

WEAVER LIBRARY PROCEDURE MANUAL

Computer Help

Crisis Contacts

Emergency Response Manual

Cataloging

- Processing Flow Chart
- Receiving New Items
- Assigning Call Numbers
- Export Document Information
- Language
- Physical processing
- Processing Items in Sirsi
- CatExpress/Connexion
- Local Notes
- Call Number Spine Labels
- Using the Label Program
- Notification of Faculty/Staff
- Removing Items
- Physically Processing for Removal
- “NONE” Webcat Records
- Moving WorkFlows settings on New PC

Reserves Maintenance

- Receiving
- Physical processing
 - Checklist: Before You Can Add Reserve
 - Add Reserve
 - Temporary Item or Instructor’s Material
 - Library Item
 - Instructor Not Found / Course Not Found
 - Deviations From One Faculty-One Class
- Look Up in the Library Catalog (iLink)
- Semester Update
- Reserve Return Letter
- Remove Reserve

Serials

- Checking in Serials in SIRSI
- Physical Processing
- Ebsco Claims
- Changes in Serials
- Creating Controls
- Serials Processed as Books
- Correct Union List Holdings
- Weeding
- Moving WorkFlows Settings to a New PC

Interlibrary Loan (ILL)

- Patrons
- Local Availability
- OCLC ILLWeb
- Borrowing
 - Requesting on Illiad
 - Processing (Ordering OCLC) Borrowing Requests
 - Copyright Compliance
 - Receiving *Non-Returnable* Interlibrary Loans
 - Receiving *Returnable* Interlibrary Loans
 - Examples and Addenda
 - Return Interlibrary Loans We Borrow (Returnables)
 - Renewal Requests
 - End of Day (Batch Updating) Borrowing—MicroEnhancer
- Lending
 - Lending Policy Overview
 - Importing ILLiad Lending Requests from OCLC
 - Processing ILLiad Lending Requests—Searching the Catalog
 - Changing Loans to Articles and Vice Versa
 - Manual Input of Lending Requests
 - Printing ILLiad Lending Pullslips
 - Updating ILLiad Lending Stacks Searching Results
 - Printing Address Labels and Invoices
 - Checking Loaned Items In and Answering Renew Requests
 - Updating ILLiad Lending External Systems
- Ariel
 - Sending and Receiving Ariel
 - Examples
 - Ariel 3.0 User's Guide
- Overdues
 - Interlibrary Loan (ILL) Overdue ILL

Overdues

- Scheduling of Billing Reports
 - Overdues (Weekly)
 - Fines (Monthly)
 - Lost Items (End of Semester)
- Running Report
- Checking the Shelves

Overdues (cont'd)

- Final Overdue Notices
- Bills
 - Weekly
 - Student Overdue Letter for \$25+
 - Monthly
 - End of Semester
- Sample Letters

Tasks

- Master List
- Detailed Lists
 - Yearly*
 - Semester*
 - Monthly*
 - Weekly*
 - Daily*
 - As Needed*
- Daily Tasks
 - Gate Count*
- As Needed
 - Adding Barcodes to Serials*
 - Making Computer Help Desk Requests*
 - Moving WorkFlows Settings to a New PC*

Patrons & Policies

- Valid IDs for Checking Out Materials
- Computer Lab Access
- Courtesy Borrower
- Patron Borrower Policies*
 - Undergraduate
 - Faculty & Staff
 - Graduate Students
 - Distance Students
 - Affiliate Faculty
 - Community
- Library Policies*
 - Children in the Library
 - Group Study Rooms
 - Interlibrary Loan Service
 - Reserve Material
 - Library Wireless Checkout
 - Library Laptop Checkout Agreement

Opening and Closing

Work Study

eLearning and Library Services Student Worker Job Description
Employment Application
Student Employee Manual General Information – Remainder can be read in the Student
Employee Manual binder on the back counter

Money

Overdues and Fines Overview
Fines (Paying in Workflows)
Procedures for Handling Revenue
Weekly Money Drawer Reconciliation/Deposit
Fax Procedures

Reports

Overview
Monthly Reports
Circulation Statistics
Electronic Database Statistics
Collection Development
Items Added
Gate Count Activity (Average Daily Count)
Overdues
Schedule of Billing Reports
Overdues (Weekly)
Fines (Monthly)
Lost Items (As needed)
Periodic Reports
Collection Development
Items Removed
Purge “Required Field”
Patron Fine Reports (Unpaid, but not monthly)
Quarterly Reports
Circulation
Interlibrary Loans
Annual Reports
Circulation
Interlibrary Loan Summary Report
Inventory and Collection Valuation
SIRSI Report Scheduling Basics
Year End Summary

[Tabs]

Computer Help
Computer Help

Money
Money

Crisis Contacts
Crisis Contacts

Reports
Reports

Emergency Response
Emergency Response

Cataloging
Cataloging

Reserves
Reserves

Serials
Serials

Interlibrary Loan
Interlibrary Loan

Overdues
Overdues

Tasks
Tasks

Patrons & Policies
Patrons & Policies

Opening/Closing
Opening/Closing

Work Study
Work Study

WEAVER LIBRARY PROCEDURE MANUAL

Cataloging

- Processing Flow Chart
- Receiving New Items
- Assigning Call Numbers
- Export Document Information
- Language
- Physical processing
- Processing Items in Sirsi
- CatExpress/Connexion
- Processing Ebooks in Sirsi
- Local Notes
- Call Number Spine Labels
- Using the Label Program
- Notification of Faculty/Staff
- Removing Items
- Physically Processing for Removal
- “NONE” Webcat Records
- Moving WorkFlows settings on New PC
- Miscellaneous

CATALOGING: Processing Flow Chart

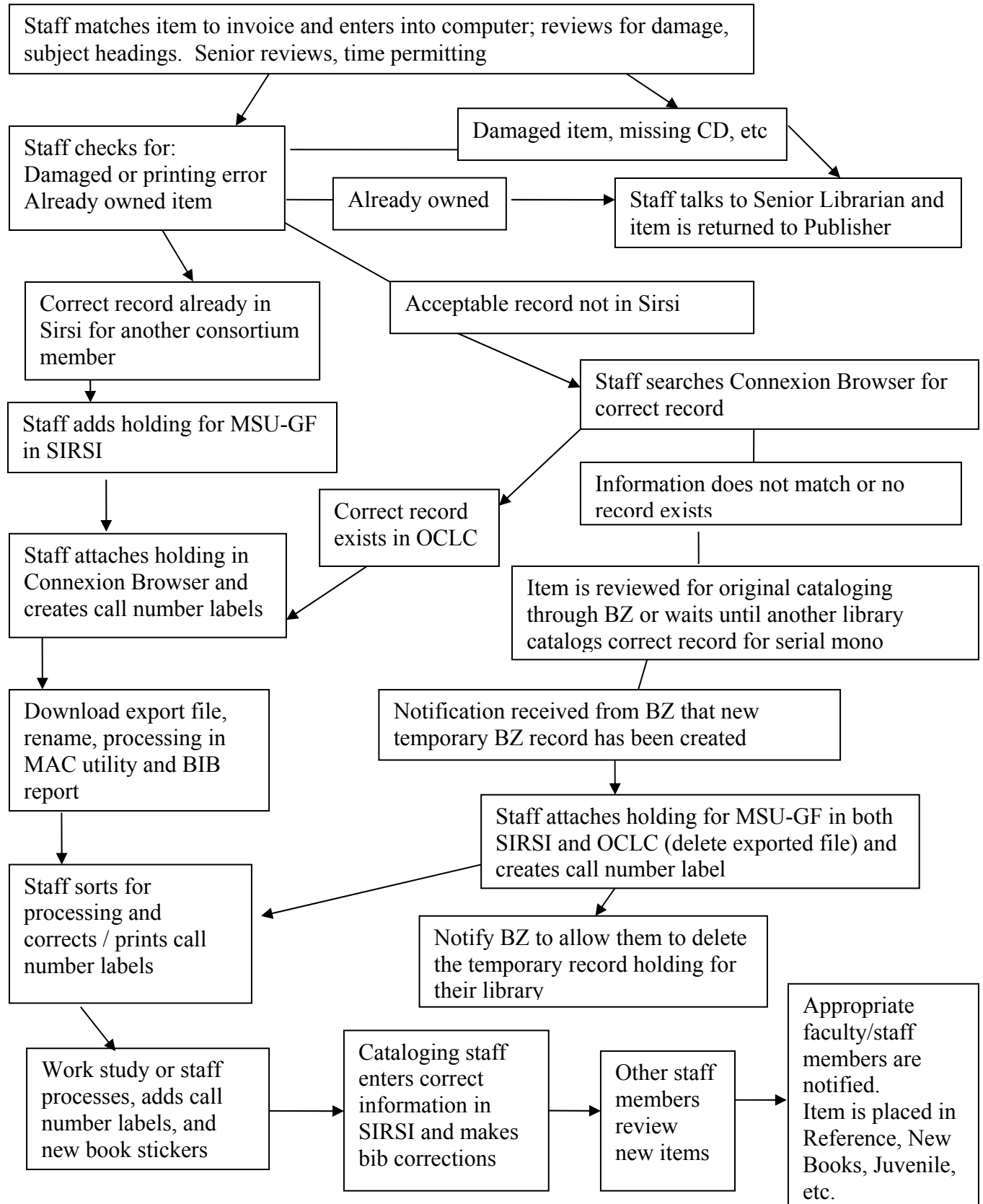

CATALOGING: Receiving New Items

When a new shipment comes in, the Librarian checks the materials against the acquisition records. This tracks dates, items, costs, etc.

When the Librarian isn't present and a shipment comes in, just put the box in the Librarian's office.

The Librarian leaves the item form or puts sticky notes on each item containing information such as: who to notify about the item when the processing is complete, the cost of the item, if it's a reference item, or any other pertinent information. Leave the information with the item until processing is complete.

After the Librarian has prepared and reviewed the new items, the new items are given to the processing technician.

The technician will check the records to see if the Library already has the item contained in our library's holdings collection. Also before any further action, the materials should be checked for any apparent printing problems or damaged items (be sure to also check CDs/DVDs). These items should be brought to the attention of the Librarian for evaluating whether the item will be returned to the publisher. If a disc is damaged, the publisher will want the book and the disc to be returned at the same time.

Review the items for special processing adjustments will be needed during processing (especially information on AV items). Let the work study know ahead of time about any processing changes.

Most mono serial items will be cataloged separately to allow the items to appear in iLink properly.

Items will be processed for New Books area except Reference, Juvenile, or donated selections (which will go directly to the Stacks).

The items should then be sorted for Reference, easy covers (hard/stiff or soft/roll), etc. and placed on the work study area for physical processing.

Place a "Process New Books" slip with the appropriate information on each stack for the work-study. Use sticky notes to inform the work studies on special processing information.

CATALOGING: Assigning Call Numbers

When a book has been received, most bib records will include a Library of Congress Call number behind the title page under, “Library of Congress Cataloging-in-Publication Data”. Usually use the number located in the book but utilize the most appropriate call number for our collection.

Reference items will have REF on the top line of the Call number. Bottom line of the call numbers will include; DVD, VIDEO, OVERSIZE, Juvenile, v.# (next line) n.#, etc.

If there is no Library of Congress call number listed, check to see if another Sirsi library has the book for the LC call number. Carefully check the information such as name, author/editor, publisher, date, edition, ISBN, page information, etc. to see if it is an appropriate match.

If the correct match is not located in other SIRSI libraries, check World Cat for the item. Preferably use the ISBN number to locate the book. Check all information to locate the correct record. Find the correct item and click “libraries that own item” to open up a listing of the libraries that have the item. Look through university and college libraries to find for appropriate LC numbers by searching through each library’s catalog. If there is still no call number, ask Bozeman for a correct number.

If needed, logon Connexion at <http://connexion.oclc.org> and select the Express tab

Authorization:

Password:

Click “CatExpress” tab.

In the “Search for” box, enter the ISBN. (preferred method). Use the “x” at the end of the ISBN number if one is included.

For a more detailed Search, select Advanced under the “Basic” drop box option

If you are presented with choices, check each record for the best match. The “LC” noted record is usually preferred but a different one should be used if more appropriate to our new item. Use the Advanced search for Government document, Videos, etc.

If a LC number is not located in any of the searches and the item is a new selection, titles generally will appear within a week or two. Periodically, check records for the item. We have a history of receiving our items in our Library quickly.

Any copy information not found should be referred to Bozeman for original cataloging. Photocopy front and back covers, title page, back of title page, and table of contents. Also, include any information for Roman Numeral pages in the front of the book, bibliography, illustrations, tables, etc. Mail copies to the catalogers, Sandy Tetro or Amy Carver, in Bozeman.

CATALOGING: Export Document Information

Because we are a smaller library in the consortium, exporting downloaded records is the most appropriate method for our Library. This also allows for better quality control and keeps from overlaying existing bib records of other consortium libraries that might have made record adjustments.

In order to be able to process items from Connexion into SIRSI properly, the following two steps need to be adjusted in MS Internet Explorer to allow records can be downloaded from OCLC to SIRSI. This also permits the security system to remain intact.

(Important! Both adjustments need to be made to allow the importing of records.)

The process takes two steps: 1) *Tools/Pop-up Blocker/ Pop-up Blocker settings/ add connexion.oclc.org*, 2) *Tools/ Internet Options/ Privacy/ Sites/ Manage Sites/ allow - oclc.org “always allow”*.

NOTE: Deletions will not appear on the Export Document File

Once the transfer file has been initialed, and the received Windows “Save As” dialog box appears, the transfer must be completed. Files will be retained in Connexion for awhile if you need to wait to download the records.

If there is a mistake, it is alright to go back into Connexion and reconnect the record to our holdings. This does not create duplicate items on the Connexion side. Then download the new created export file records. Bringing the records over again from Connexion to SIRSI will overlay the items.

Cataloging Export Directions

Steps to download export files from OCLC Express

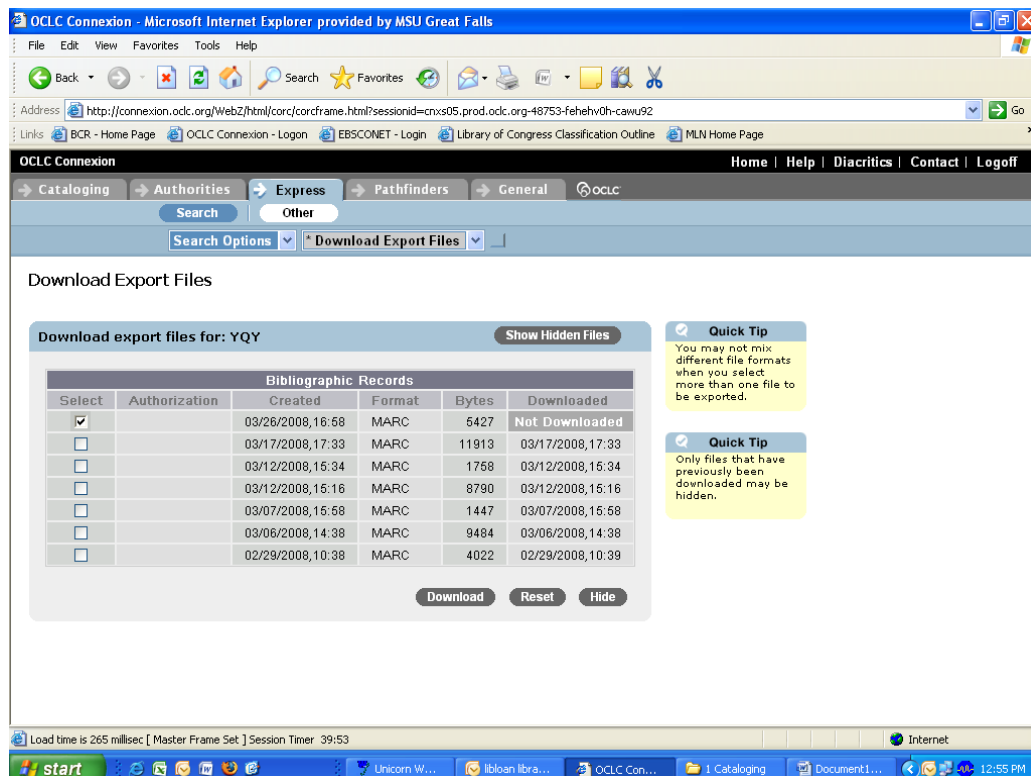
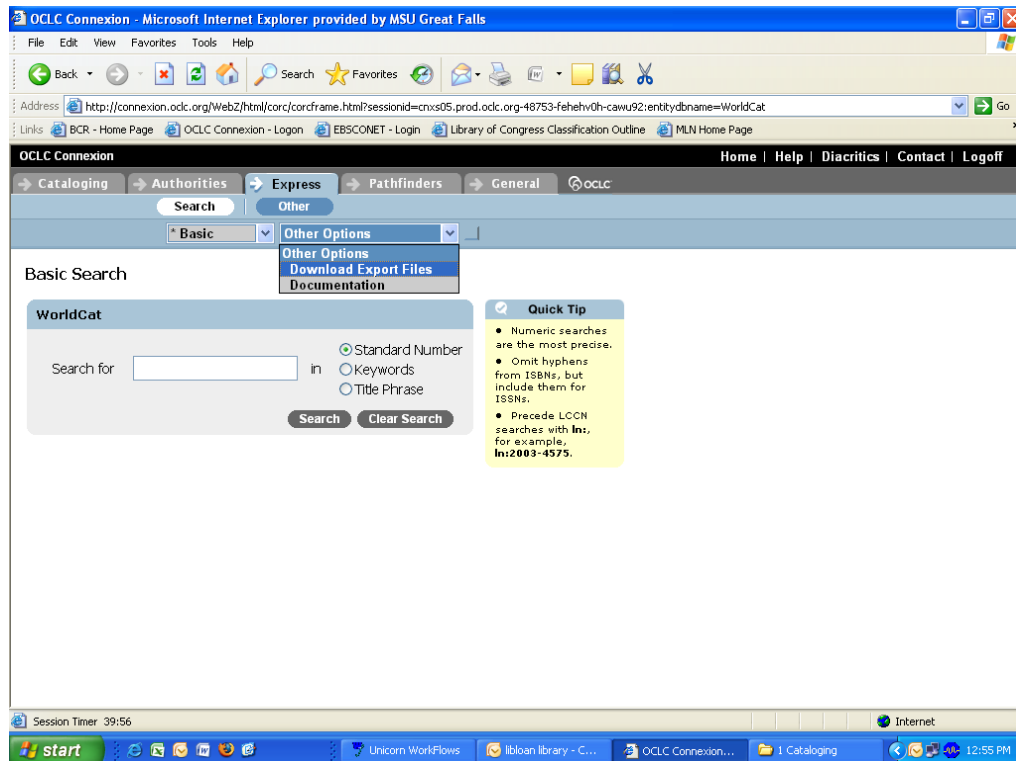

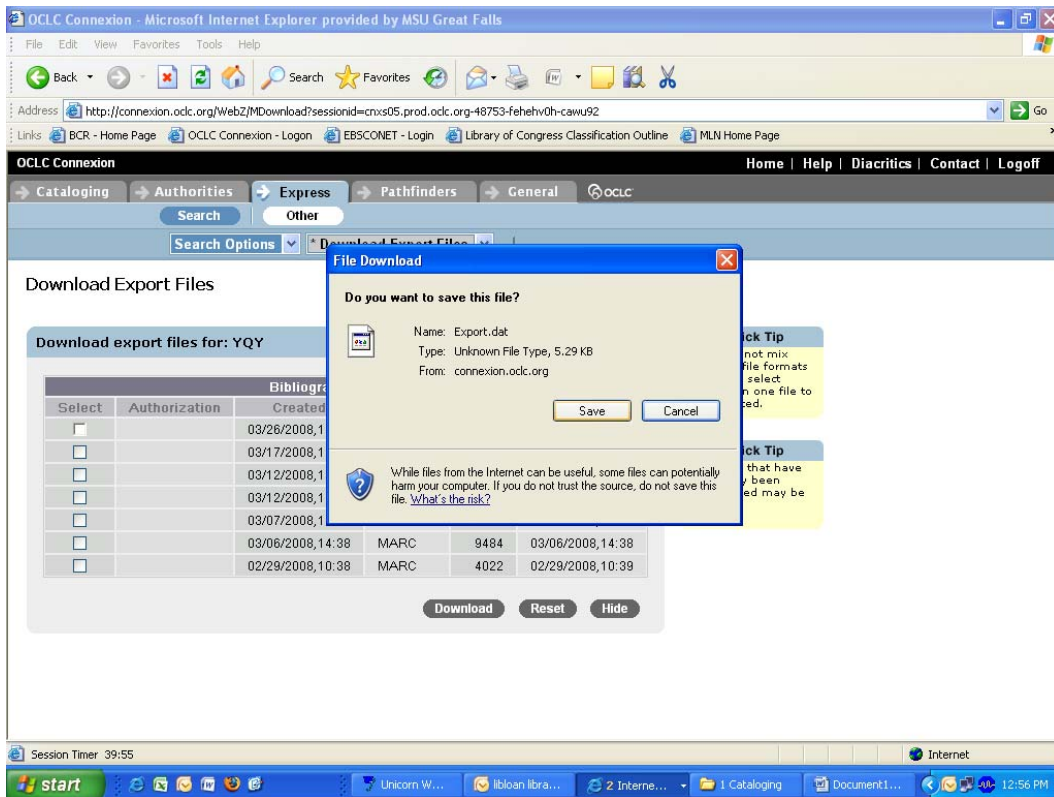

If desired, rename the file to be processed from the “export.dat” to “gfmarc.dat”.

Files already in SIRSI that you just attached in Connexion in a separate batch, will have to be downloaded and deleted. If desired, you can name the files to be deleted as “delete.dat”.

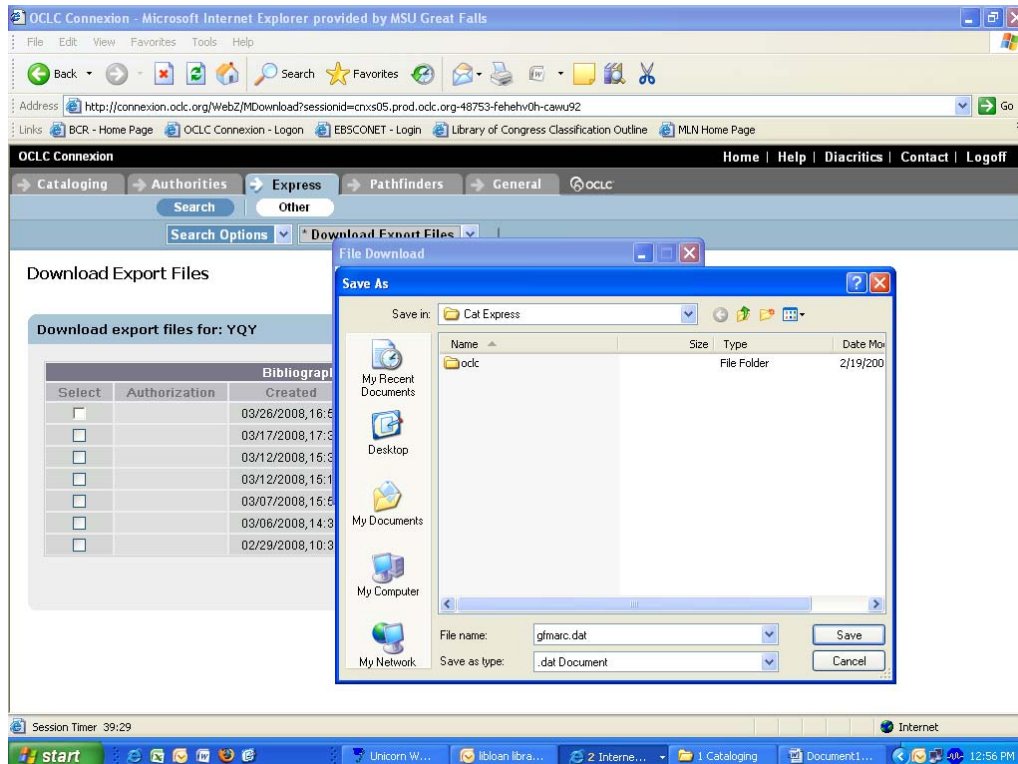

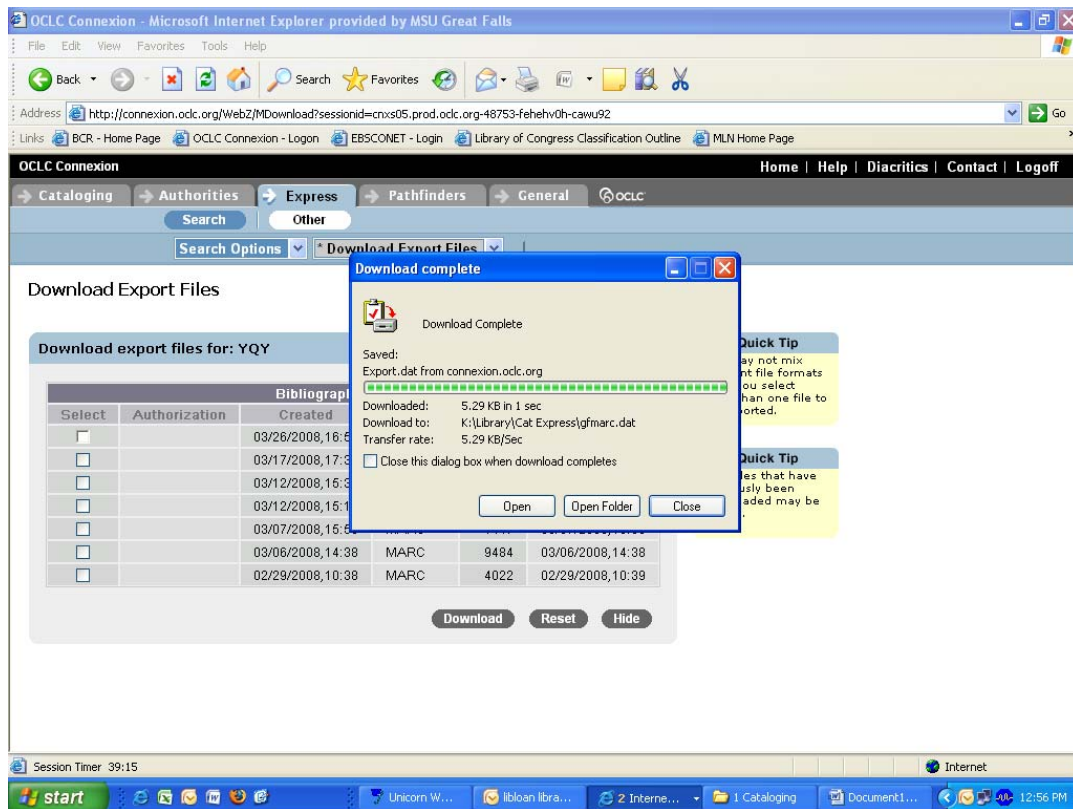
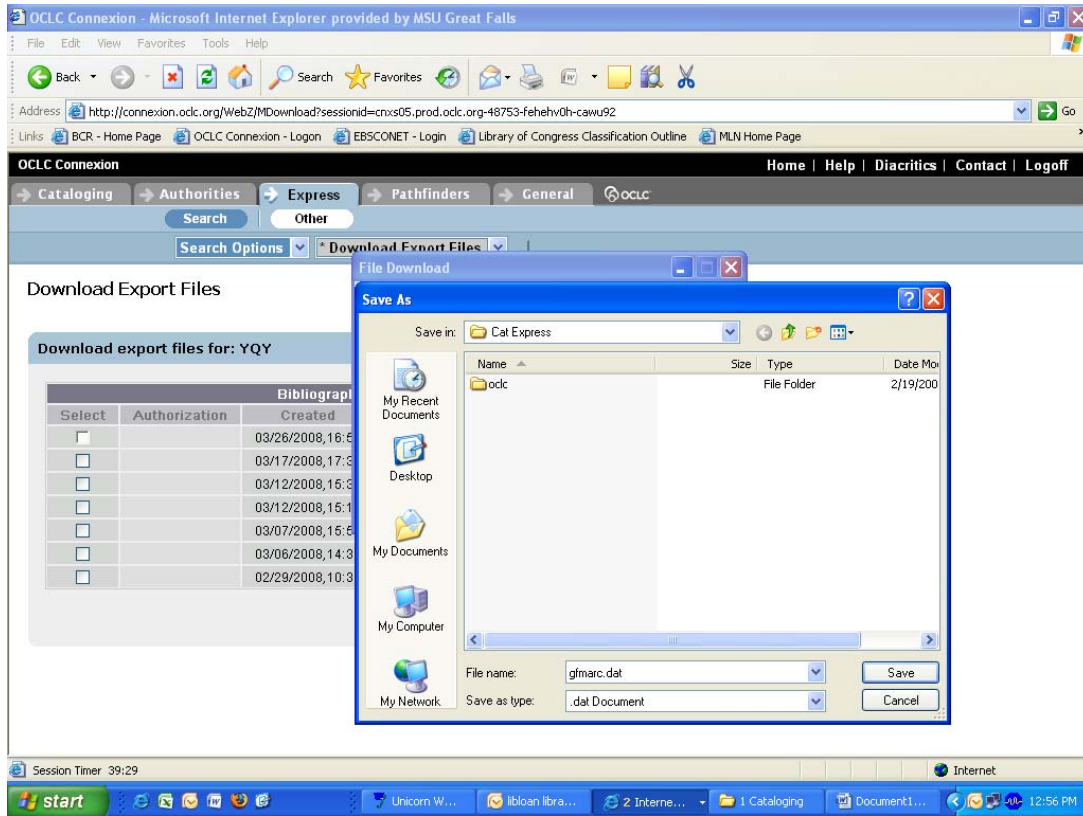

CATALOGING: LANGUAGE

If the book or serial has been published outside of the United States (including Canada), it is considered foreign. “Georgia O’Keeffe” was one book that appeared to be an English record but created a problem due to this situation.

When you are making a search in Connexion, you can select “English” for the language under “Advanced Search”.

Records in OCLC Connexion can seem to be an English version but can actually be not an English record. Do not rely on the initial document line that states a language in WorldCat for this information but look in other library records or check the fixed field information if possible.

The problem will not be apparent until the record is imported and the language appears in the Fixed Fields. This will not be apparent in the CatExpress record during processing. You can see some fixed field information in the “MARC Display” button selection in the individual CatExpress record.

Of course, some items are appropriate as a foreign language in our collection such as the “Alvar Aalto” video which is Finnish with English, Spanish/English dictionaries are considered both or multi-language, etc.

Before processing these books or serials of this type, check the language in the appropriate record in World Cat under the ISBN/ISSN number preferably. If you are unsuccessful, check by author and/or title to locate the item. **Setting the language search criteria to English to locate the correct record will avoid problem situations.**

If there is no appropriate English version, contact Bozeman to decide whether to make a record correction or to create an appropriate new record at their discretion.

CATALOGING: Physical Processing

This is a general overview of the procedures for physical processing of items.

Work study students typically do physical processing of items, so the details and steps for the most current procedures can be found in the work study manual. The procedure below is a general guide. Technicians wishing to physically process items should read the section of the work study manual entitled Processing Materials.

Place a “New Books- Please Process” checklist with the pile. This checklist guides the work study through the processing so s/he doesn’t leave anything out.

The checklist includes the steps:

- easy covers (if needed)
- property stamp
- barcodes
- security tag
- book pockets
- dot the REF books
- labels (CD, etc.)
- return to library tech.

The steps are in a logical order which should be followed because easy covers must be applied before other items such as barcodes, dots, etc are applied. (There are examples of errors on the shelves of easy covers over sticky-notes, call numbers, barcodes, and other incorrect procedure problems.) If this procedure is followed, there will be less problems when holdings are processed for discard.

Work study students should initial the steps that they have completed. This allows identifying specific individuals to correct any errors in processing procedures.

It is beneficial for the work study to have the processing information opened for referral until the person is very familiar with all the steps.

Caution – The name stamp has a problem of bleeding through some pages. Tell the work study to be careful watch for any affected information on the backside of the page before stamping. If the work study has any question, they should bring any problems to the attention of the technicians.

Encourage the work study students to ask any questions. It is important that all marks, barcodes, etc., be placed consistently in the same areas on materials. If there are any variables (i.e. a barcode cannot be placed on the inside of the cover because it would obscure information on the endpapers), the work study students should ask a Technician before proceeding with processing.

CATALOGING: Processing Items in SIRSI

After the work-study has processed the items and returned them to the technician, the technician begins the cataloging process.

IMPORTANT: If the item has been published outside of the US, set the search for English in WorldCat. This applies even if an English ISBN is included.

Check Sirsi first to evaluate if another SIRSI library has previously cataloged the appropriate record. In this case, you just attach our holding to their record. Set aside any items that do not have records in SIRSI.

In the cataloging menu, click ***Item Search and Display***

Enter the title or author and title

Hit Enter key

- a. **If there is an appropriate match in SIRSI**, carefully investigate to be sure title, author, page numbers, publisher, edition, etc. match. It is helpful to list the OCLC number of the record on the book slip.

SET ASIDE ANY BOOK THAT DOES NOT HAVE AN APPROPRIATE MATCH

If there is an appropriate match displayed in ***Item Search and Display, All Libraries***

Click ***Call Number and Item Maintenance***

Find the correct record

Click ***Add Call Number*** making sure that it is listed for Great Falls.

Click ***OK***

Enter our call number, barcode, and price, etc.

Make sure the Type, Home Location, Current Location, and Circulate boxes are correctly marked. Generally, use NEW BOOKS for all locations

Reference books do not circulate. If it's a REF book, uncheck the circulate box.

Make any needed adjustments in the BIB record.

Click ***Save*** to save the changes, mark the call number and OCLC number on the book slip

Click ***Close*** and look up the next item

Next - Open CatExpress/Connexion

Locate appropriate record in SIRSI (preferably using the OCLC number).

Recheck information on the record with all item information.

Attach a Great Falls holding to the appropriate record

Create a label. Adjustments can be made now or just before printing later.

When all files are cataloged successfully by attached to the Great Falls holdings,

Click ***Other Options/ Download Export Files***

Click ***OK*** for ***Continue with Download Export Files?***

Click ***Save*** for ***Do you want to save this file?***

The ***Save As*** action for Cat Express will appear - Click ***Save***

A message will pop-up ***Download Complete*** - Click ***Close***

Click ***HERE*** on the bottom of the ***Download Export File in Progress*** when all actions are completed

A *Cataloging Successful* message will appear on the Cat Express site
Log Off

- b.** Go into the Cat Express folder and delete the EXPORT.dat file. This record is already in Sirsi. Do not process through Sirsi again or problems could occur when existing records are overlayed.

CATALOGING: CAT EXPRESS - Connexion (Browser)

All books that were set aside (not cataloged in SIRSI) will now be processed

a. Select CatExpress/Connexion

Open Connexion at <http://connexion.oclc.org/> and click on the Express tab

Authorization:

Password:

IMPORTANT – *If the item has been published/produced outside of the United States, FIRST look in World Cat for LANGUAGE (this applies even if there is an English ISBN or ISSN included), and check ANY OTHER PERTINENT INFORMATION, etc. for the correct OCLC record number.*

Search under **BASIC SEARCH** preferably with the ISBN for an appropriate match. If you do not have an ISBN number, click **ADVANCED SEARCH** and enter information such as title, publisher, etc. If you include a date, it is best to use a date range instead of a specific date. In **ADVANCED SEARCH**, select English for the language option.

Note: If an item does not appear with an ISBN/ISSN search, do an advanced search using the title and/or author and a date range. Some items will appear using this search but not an ISBN/ISSN search.

Look over the choice(s) for the correct match on title, author, publisher, pages, edition, etc. If there is more than one match, generally use the LC record.

Create a call number label through SIRSI and either adjust now or when the cataloging is reviewed later.

Click **Save to Catalog** when you find the best match.

A message will appear stating “Cataloging Successful” under the search options and the amount of records for the export file will be displayed.

Continue to attach a Great Falls holding of the remaining un-cataloged items by clicking **BASIC** or **ADVANCED** to the appropriate record. Utilize the ISBN if possible.

After the records are cataloged in CatExpress/Connexion, they need to be imported from Express into SIRSI.

When all files are cataloged successfully by attached to the Great Falls holdings,

Click **Other Options/ Download Export Files**

Click **OK** for **Continue with Download Export Files?**

Click **Save** for **Do you want to save this file?**

The **Save As** action for Cat Express will appear - Click **Save**

A message will pop-up **Download Complete** - Click **Close**

Click **HERE** on the bottom of the **Download Export File in Progress** when all actions are completed

A **Cataloging Successful** message will appear on the Cat Express site

Log Off

The MARC records are now in the Library’s common drive. Now they can be adjusted in SIRSI.

Records that are newly imported from Connexion have minor inaccuracies that need to be cleared up so that the corrected record will be accessible to staff and patrons.

Open Library/Cat Express and rename the file from EXPORT.dat to gfmarc.dat

IMPORT MARC RECORDS

Go to the Utility menu

Click MARC Import

The MARC Import default properties must be set to the following properties:

Display property page: Wizard Startup Never

Catalog format: MARC

Authority format: LCSH

Click "OK"

In the Import tab:

File type: Marc Sirsi flat

Source: K:\Library\Catexpress\gfmarc.dat

Destination: gfmarc.dat

Click "Import"

Is diskette ready? Click "Yes"

Are there more files to upload? Click "No"

Close the Word or Notepad window that pops up

Close the MARC Import window in Sirsi

SCHEDULE NEW REPORT

Go to the Reports menu

Click "Schedule New Reports"

In the Templates tab, click "GF bibload"

Click "Setup & Schedule"

Click "Run Now" again

Click "Close"

It seems to work instantly unless the report scheduler is working.

Click "Finished reports" (the papers with a checkmark)

Click "GF bibloa"

Click "View"

Click "OK"

Close the Word or Notepad window that pops up

Close the "Finished Reports" window in Sirsi

MODIFYING NEW RECORDS

New SIRSI records need information adjusted or added, such as barcodes, prices, call numbers (sometimes); and their item type, locations, and circulation status.

To fix this...

Go to the Cataloging menu

Click "Modify Title" Under Titles drop down

Search for item using GREAT FALLS as the Library

Review the Bib record for accurate information and make any adjustments at this time.

Enter the proper:

Call Number

Class scheme should be LC

Item ID (barcode)

Price -- *Donated items are listed for \$10.00*

Item type

Use **NEW BOOKS** for Home and Current location. (Use **REFERENCE** for reference or **JUVENILE** for juvenile materials by selecting the side drop down box or **VIDEO** for any AV materials.

If it's a REF book, uncheck the circulate box.

Any comments needed can be added at the bottom or if appropriate in the Bib record

Click "Save"

Click "Return to Search" and continue through the stack until all items are adjusted.

The completed items are ready to have the call number labels created and added to the items.

The cataloged items are now ready to add call number labels.

CATALOGING: Local Notes

There are several types of local notes.

In Modify Title

Field 583 “BZ deleted 247 field (kf 5/03)”

The 583 field should be used to indicate additions, deletions, or corrections

Field 586

The 586 field will indicate award notes, etc.

Field 590

The 590 field has a limited space. This would be used if there is an autographed copy, if was a variance from the Bib record for the Great Falls Library (such as “GF has volume 1 only. 3/04 nh), etc.

Notice that the line always contains GF, contains a period, dated, and initialed. These notations are always very brief.

The notation will only appear in the Bib record but can be selected in iLink if you wanted to find all Bib records with GF in field 590. “GF {590}”

In “Modify Title”

Vol/Copy

There are three new lines for “Extended Info”

CIRCNOTE

PUBLIC

STAFF

These fields have a large space capacity. The extended info is a valuable tool so use discretion about information and length of notation. They are also versatile in display.

At the present time, do not use CIRCNOTE.

The PUBLIC notes will appear in iLink besides SIRSI. Do not place any information that pertains to a particular student or other confidential information in this field.

Any information that needs to be kept to staff only should appear in the STAFF note.

When you are selecting properties, do not check “display public note on hit list”. Most public notes are lengthy and contain unneeded information for this selection. Do select “display staff note on hit list”.

CATALOGING: Call Number Spine Labels

Call Numbers are now created on the OCLC Label Program.

Open all saved labels by clicking the “search” button.

At the end of each line, press “delete” and then press “Enter” to remove any automatic spaces set by the program. (This will delete the extra space that is on the beginning of subsequent lines that are not visible but will print with the space.) Remove automatic periods at the beginning of any lines.

To create labels manually for any other items, click the **Create Label** button. There are eight spaces per line for this program.

You will need to add “**REF**” on the first line for Reference items.

Volume and Number should be added on the bottom two lines as v.#, (next line)n.#. Utilize “c.” for copy and “v.” for volume. Any other variations should be checked by the Library staff.

Use “**Juvenile**” for juvenile books, “**OVERSIZE**” for large books, “**VIDEO**” for videos, “**DVD**”, “**CD-Audio**”, “**Video Guide**”, “**Cassette**” etc. , or any other AV-Media item should have the item type name included at the end of the call number.

Select “2” for the amount of labels for Video items (one is placed on the outside case and another is placed on the item itself).

Print labels and attach to the items. Place a protective cover over the label.

Place a “New Books” sticker in the front upper left-hand corner of the item.

Any items that will not be placed in “New Books” section or items with no faculty/staff notification should be shelved in the appropriate Library area at this time.

USING THE LABEL PROGRAM

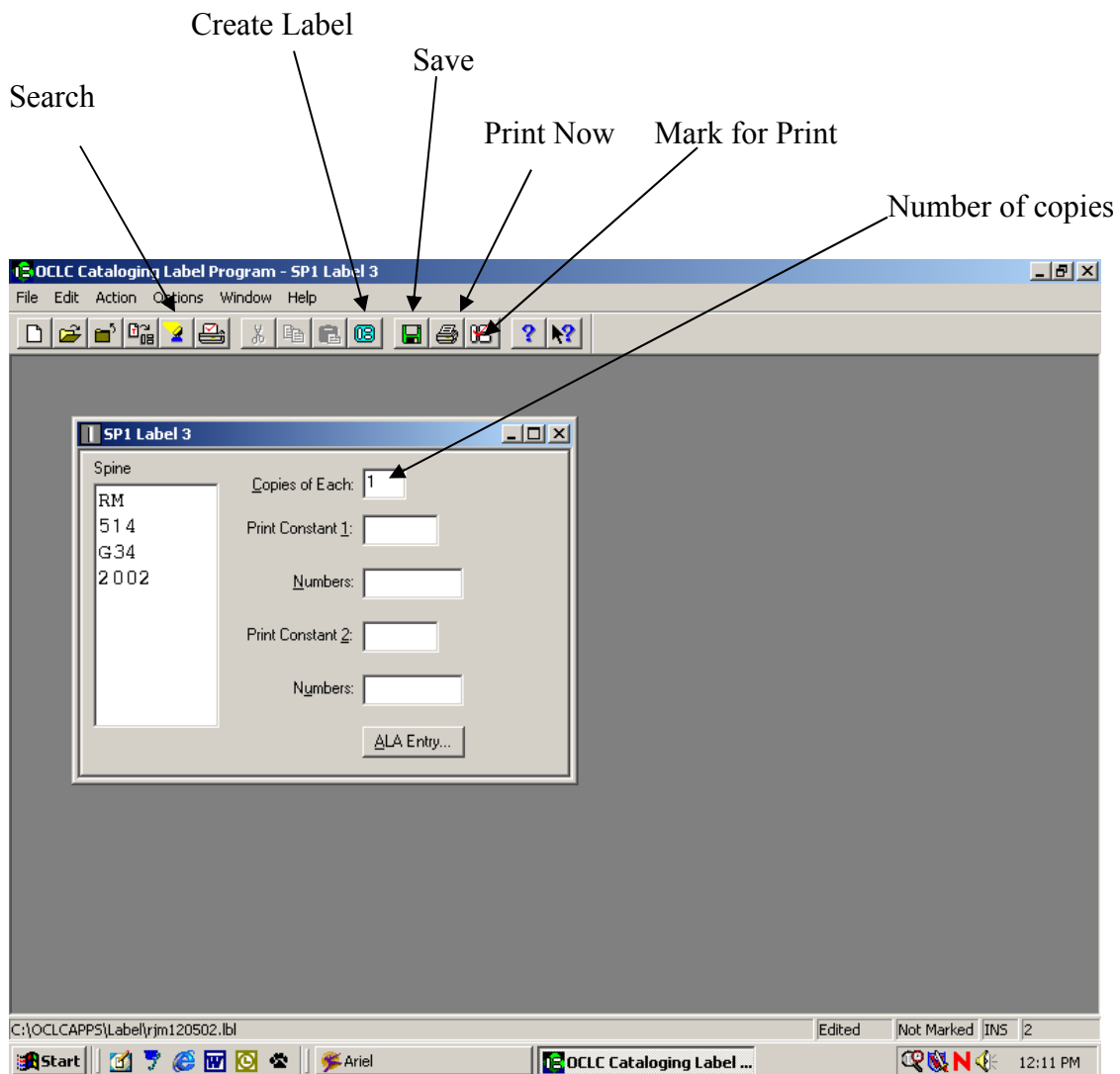

To create Call Number Labels:

Click on "Create Label" button

-Type label (defaults are already set—do not adjust!!!)

-For videos, you will need to adjust the "Copies of Each" to 2 (be sure to adjust it back for the next label.

-Delete at the end of each line and press "ENTER" to start each new line. (If you just arrow down to the next line, the alignment will be off.) Delete the extra space on line 2 that CatExpress creates. Remove any periods at the beginning of any lines.

Click on "Save" button

When all labels are created, click on "Search" button (not marked or printed)

-Highlight record and click on "Mark for Print" button

-At this point, labels can be edited.

When finished, click on “Print Now” button

Call Number Label sheets will print upside down with the top edge closest to you. The program is set up to prompt you on which row and line the labels should begin to print.

Avoid running the label sheets through the copier repeatedly. Use the older small Call Number sheets with the typewriter for just a few labels.

DEFAULTS FOR THE OCLC LABEL PROGRAM

- 1) The spine label can be up to 8 characters wide and up to 9 lines long
*For our curriculum collection please use CRC as the abbreviation.
- 2) The label we use is Highsmith **SP1-Order Number L97-31194** (One spine label no pocket -- 8 labels across and 5 labels down).
- 3) If you need to check for alignment, print a copy of the labels on piece of scratch paper. The labels will print upside down with the top closest to the front of the feeder tray.
- 4) The Defaults should be as shown:

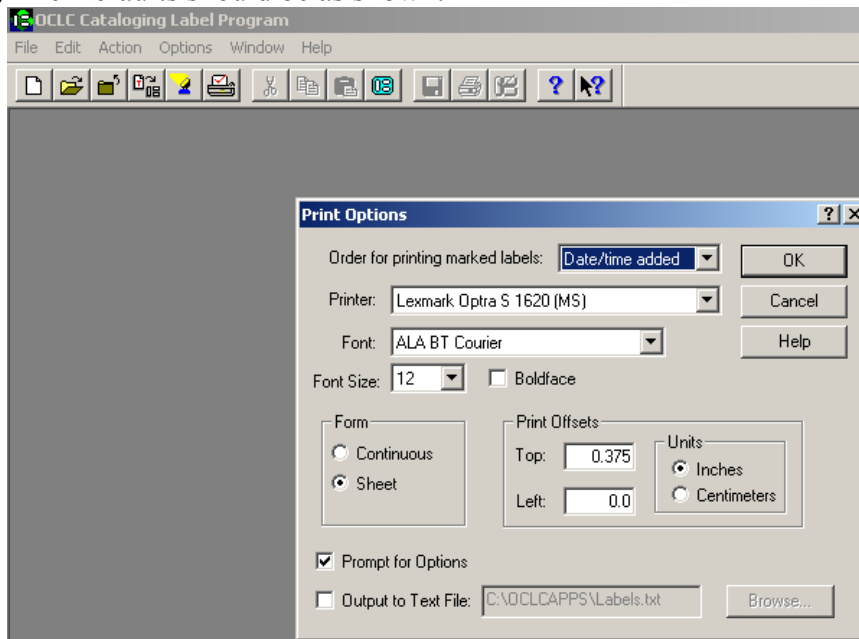

To get this menu to come up you need to click on the **Options** drop down menu and select **Print**.

- 5) Check the User Guide for additional information on how to use the label program.

CATALOGING: Using the Label Program

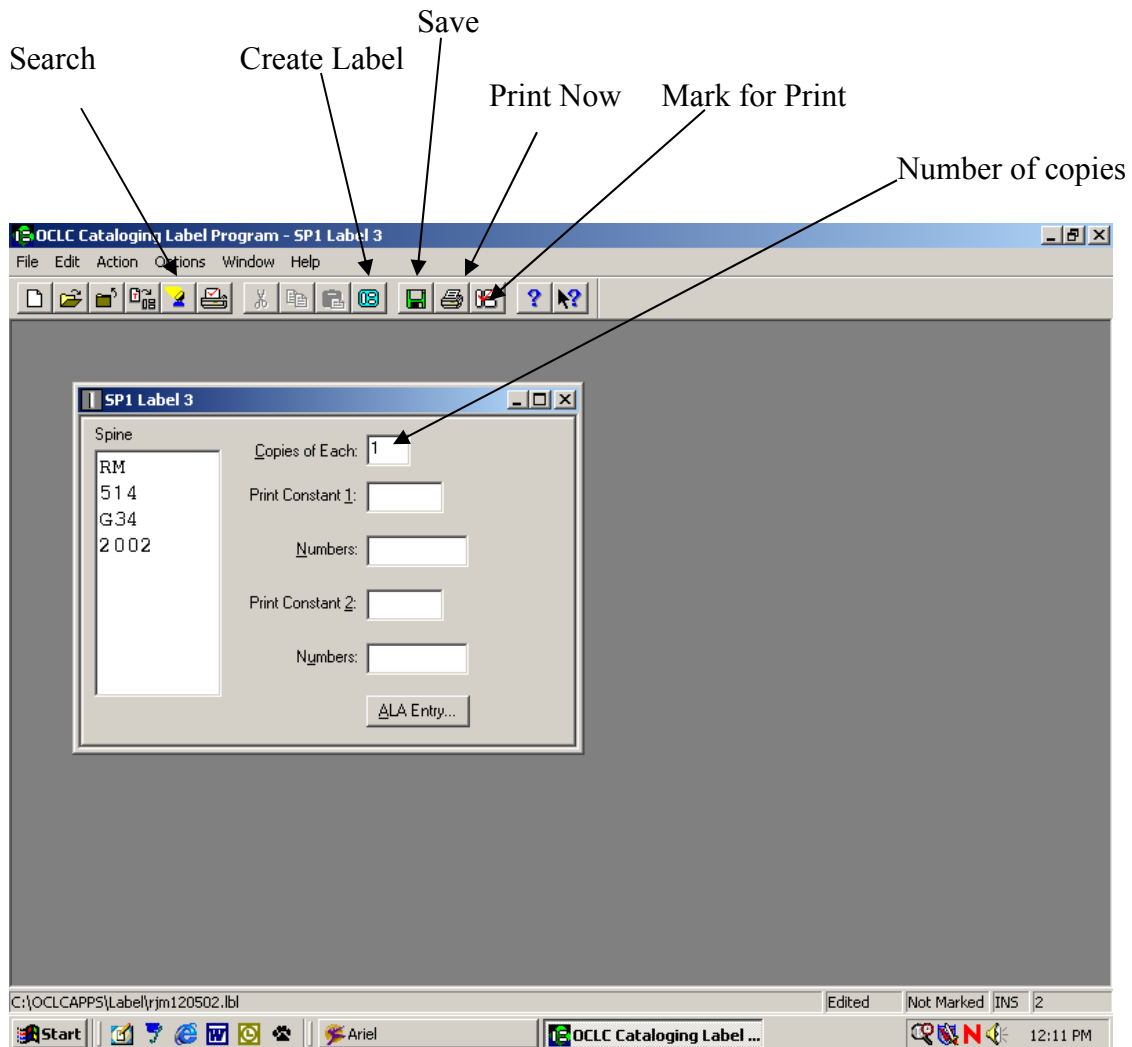

To create Call Number Labels:

Click on "Create Label" button

-Type label (defaults are already set—do not adjust!!!)

-For videos, you will need to adjust the "Copies of Each" to 2 (be sure to adjust it back for the next label.

-Delete at the end of each line and press "ENTER" to start each new line. (If you just arrow down to the next line, the alignment will be off.) Delete the extra space on line 2 that CatExpress creates. Remove any periods at the beginning of any lines.

Click on "Save" button and "Mark for Print"

When finished, click on "Print Now" button

Call Number Label sheets will print right-side up with the top closest to the printer. The program is set up to prompt you on which row and line the labels should begin to print.

DEFAULTS FOR THE OCLC LABEL PROGRAM

- 1) The spine label can be up to 8 characters wide and up to 9 lines long
- 2) The label we use is Highsmith **SP1-Order Number L97-31194** (One spine label no pocket -- 8 labels across and 5 labels down).
- 3) If you need to check for alignment, print a copy of the labels on piece of scratch paper. Place the label sheets print side up on the front feeder tray.
- 4) The Defaults should be as shown:

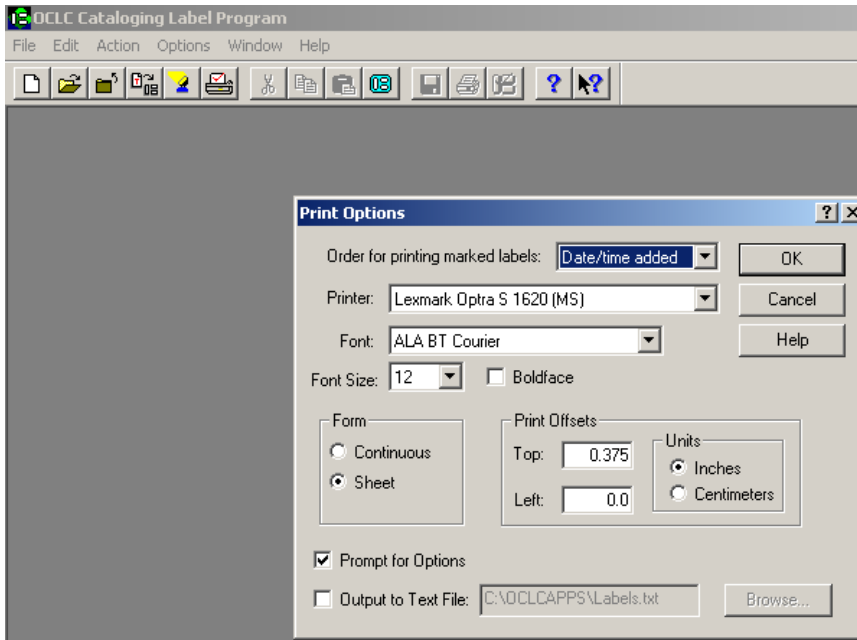

Adjustments in the top or left print offset might be needed for special instances.

To get this menu to come up you need to click on the **Options** drop down menu and select **Print**.

- 5) Check the User Guide for additional information on how to use the label program.

CATALOGING: Notification of Faculty/Staff

Once the item is physically processed and fully cataloged, look for faculty/staff notification notes on the processing note. If there is any other faculty/staff member that might be interested in notification, send an e-mail to that person also.

The message should include where the item library location, title, author/editor/publisher, and any appropriate information, such as version, etc. Indicate on an entry line where the item will be located in the Library.

The e-mail message should be like the following:

Subject: *New Selection in Library*

Message:

There is a new selection in the Reference area of the Library:

“Alternative Medicine: the definitive guide” edited by Larry Trivieri, Jr and John Anderson. REF R733.A46 2002

There is a new selection in the New Books area of the Library:

“Keeping a Nature Journal: discover a whole new way of seeing the world around you” by Clare Walker Leslie and Charles Roth. QH81.L595 2003

Library Staff

This is the final step in cataloging. When you are done, remove all sticky notes and miscellaneous processing papers from the item.

Books and videos set in the “NEW BOOKS” area for display will have a “New Books” sticker set in the upper left hand corner of the front left hand corner of the book/video. The item will temporarily remain in the NEW BOOKS area.

Reference, Juvenile, or donated items should be processed directly into the appropriate Home Location area of the Library.

CATALOGING: Removing Library Items

Entering on Removed Items List

First, All items to be removed should be first entered in the Library folder under Inventory Insurance/Removed Items list/ for the appropriate month/year file. There should be a new file for each month in which an item was removed. All the information needed for the form should be taken from the item file.

Removed items lists assist with library statistics and the librarian with collection development..

Removing from Connexion

Second, all items need to be removed from our holdings in Connexion.

Log into Connexion : <http://connexion.oclc.org> Authorization: Password:

Click on the *Express* tab

For books, click *Basic* on the left side of the screen. Try to search by the OCLC number of the record. Older records will not contain the correct number (such as merged WLN records). For items without an ISBN, click *Advanced* on the left side of the screen. Be sure to use a wide date range to locate old records. Not all of the records will include the right date.

In the basic search, type the OCLC # (preferred) or the ISBN # in the search box.

Make sure standard number is selected

Click *Search*

In the advanced search type in the OCLC number or use the following information: type the title, a date range of publication (especially on older items), item type or anything that will help you find the item

Click *Search*

Look carefully over the choice(s) for a match on OCLC number, title, author, publisher, pages, edition, etc. The item attached should say that it is "Held by YQY" (YQY or YQYQ is our library code).

Note: Older copies in our Library may not match any item that states "Held by YQY". Some items in the past were only cataloged locally and not internationally in Connexion.

Be sure to check the item not located by an ISBN number by searching the author or title before deciding that there is no local record attached in Connexion. Use a ten year date range search to locate a difficult item.

Also, some items that are received annually (or semiannually) are attached to the same file serial record. Do not delete Connexion records that might have multiple files or years attached to the same or generic record for the MSU-GF Campus Library.

If you come across any unusual situation or markings, notify the Librarian to determine how to proceed. You can always contact Sandy Tetro or Amy Foster in Bozeman for correct procedural information.

Click *Delete Holdings* A warning screen comes up to ask if you're sure you want to delete-- click *Yes*.

To continue to the next item, click the *Basic* or *Advanced* search on the left side of the screen.

To exit Connexion completely, click *Exit* in the upper right corner. (Export File Documents will not be created for deletions.)

Removing from SIRSI

Third, open Sirsi to the cataloging toolbar

Locate the record using Item Search and Display. Check it carefully to make sure that it is the correct item for Great Falls library.

There are still some older volumes have not been recorded in Connexion. Also, be sensitive to the records that might have multiple volumes or years attached to the same records for either GF or other consortium members. You should only remove the pertinent item from those records; do not delete the entire record (title) for these items.

If you are sure you have selected the correct record under an item search,

Click *Delete Title, Call Numbers or Items* (under the *Titles dropdown under Cataloging menu*)

Search for the title in the **GREATFALLS** library (note: this process works best by using the title – *NONE records will be created if this step is completed improperly*).

Double check that the record matches the item by the **Item ID**

Place a checkmark to the left of the item that is being removed

Click *Delete*

A warning screen will pop up.

Click *Remove*

Click *Close*

CATALOGING: Physically Processing for Removal

When items are ready for removal processing we donate most items removed from the collection to AAUW for their book sale. Medical books are NOT recycled because the information is outdated and not appropriate for distribution. The librarian will indicate exceptions with a sticky note.

All markings need to be removed or crossed off with a permanent marker. Work-study students complete the following steps:

- Desensitize the books
- Remove spine label
- Remove barcode
- Remove reference dot
- Remove book pocket
- Black out library address stamps
- Black out call number that is inside book

Any items that can not be removed without creating physical damage can be blacked out with a marker or the front portion of the book pocket can be removed.

Place the item in the AAUW pile or set aside for recycling or discard as noted above.

CATALOGING: “NONE” Webcat Records

In cases of improper cataloging or rare problems with SIRSI processing especially with some of our older records from previous years, items can continue to show up in Webcat with a location of “NONE.” If the item is no longer in our collection, remove the item from Sirsi and CatExpress.

A report can be run to identify items by utilizing the selection “less than one”.

Do not put the “NONE” records on the removed item list. The item was accounted for when the item was originally removed from the Library collection.

A copy of a “NONE” record follows this page.

When the “NONE” record has been removed from SIRSI and CatExpress, note on the printout the date that it was fixed. The completed printout is filed in the cabinet.

AS NEEDED: WORKFLOWS SETTINGS

How can we keep existing WorkFlows settings when moving to a new PC (i.e. workstation)?

Many of the WorkFlows settings are determined by the properties file used by the login. When a user logs onto a new PC using the same login as previously, any settings that were saved to the server will be downloaded to the new PC. However, if you want to retain the settings the user had saved to his/her PC, you will need to copy some files from that user's PC to the new PC.

From the user's existing PC backup the following files:
C:\Program Files\Sirsi\Workflows\property.dat and C:\Program Files\Sirsi\Workflows\ToolCust* (whatever files are in that directory). Since each user might have a different WorkFlows setup, each fileset on each PC will need to be backed up. On the new PC, download the WorkFlows client as usual. Test it to be sure it operates normally. After you are sure it is working, then reload the backed up files overwriting the files if they exist on the new PC. Close WorkFlows, and reopen it. It should display the settings you had previously saved.

--From the Sirsi Website, courtesy of Doralynn Rossman, 5/3/04.

CATALOGING: Miscellaneous Instruction

Display for iLink

130 (uniform title), if no 130 present, then 245 (Title proper) will display or alternate titles go into the 246 (alternate title) 245 should be primary - contact Amy if there is a problem

Multiple DVD, video, etc sets should be broken down for short viewing times (per BZ)

The real time web link for Connexion does not have to be upgraded. Any concerns for an OCLC product that Bozeman cannot answer should be addressed to Regan Harper at BCR. Regan will let you know if OCLC should be called directly.

The criteria for OVERSIZE books in the MSU-GF Campus Library will be any item over 11.5 inches and/or 10.5 inches wide (excluding REFERENCE or JUVENILE books).

Per Amy Carver on June 9, 2003 [modified 6-9-03]:

In your bibloads the "title control number source for incoming items" should be as follows:

OCLC number (001)

LCCN (001)

OCLC number (035)

Local number (001)

Local number (035)

The box should read olnpgh

Marc import

MARC

LCSH

LDIBMARC

The hierarchy in SIRSI is : Title level / Call level / Copy level

Hierarchy: Title level/ call level/ copy level xx(----) unique can change display

Ingentaconnect

<http://www.ingentaconnect.com/content/0011-5266>

or <http://www.ingentaconnect.com/content/00115266>

both ISSN formats will connect

Do not add a new record for EBOOK's if a record already exists in the system.

If there is an addition to an electronic government source, use the following information from Jeff Edgmond for the 9/11 report: "The first ID# is for the whole report, the second is for the executive summary. You can add *EBOOK holdings to both if you want to, or just to the main report. It's better to add the *EBOOK as a separate holding, rather than just a second copy. (Always do that per earlier instruction on all holdings. NH) Use the 'Add Volumes' icon, not the 'Add Copies' one. Make the item type BOOK and the location INTERNET. For the number, you can use just *EBOOK or you can use the same number as your print copy and add *EBBOK^{sic}(*EBOOK) at the end. We've been using the *EBOOK at the end of the numbers to alert users that it's an online resource, not something that's

actually in the library. Even though the location shows as INTERNET, it's not always entirely clear to everyone."

Local decision (Amy BZ) to add *EBOOK, *EJOURNAL, *WEBSITE, to the call number

Any and all cataloging questions to Amy Fisher or Sandy Tetro in MSU-BZ

If an author cutter is used in recent literature, the author cutter comes from the 2nd letter of the author's last name; ex. "I Should Be Extremely Happy in Your Company : a novel of Lewis and Clark" by Brian Hall ISBN 0670031895, PS3558.A363.I13 2003

Any item that does not have a date, bracket the date such as "Wolf Tracks on the Welcome Mat" [2003].

If the title page and cover page are different: 245 title page primary source, 246 difference cover title

am8 records - incomplete need to be updated

"All OCLC systems that output OCLC MARC21 Bibliographic records will be modified to output different OCLC number formats depending on the number itself (e.g., ocm99999999[blank] or ocn100000000"

If you want to locate a search in iLink by ISSN/ISBN, use the following format in the search line: 1099-811X {022}. You can use this for a search of any bib line. (Be patient, this search sometimes has to be run more than once but is handy.)

If there is a problem with the title such as "Animal Rights : a historical anthology / edited by Andrew Linzey and Paul Barry Clarke" with a prior title as "Political theory and animal rights", use the following information and always include an explanation in the 583:

Delete 130

245 10 Animal rights : a historical anthology / edited by Andrew Linzey and Paul Barry Clarke.

260 30 Political theory and animal rights.

500 Originally published: Political theory and animal rights. London ; Winchester, Mass. : Pluto Press, c1990. With new pref.

583 GF deleted 130, added 246 field because of title change on later edition. (4/2005 nh)

This would also include cases such as Shakespeare and Bible

If there is a title change needed in the bib record, use the following format

100 1 Solomon, Norman.

245 10 Judaism.

246 Judaism : a very short introduction

490 01 (A very short introduction)

583 GF added 246 field. (4/2005 nh)

Title concerns (ex. Posttraumatic Stress Disorder

245 10 Posttraumatic stress disorder: malady or myth? / Chris R. Brewin

583 BZ corrected 245. (ST 3/2004)

650 0 Post-traumatic stress disorder.

Adding a series note -- Format to be used per Amy Carver 11/05/02

440 Facts on File library of American History

590 GF added 440. nh

Never end line 856 with a period.

Circ Note

Public Note - will appear in catalog

Staff Note - will appear in comments - ?report run?

583 local note that does not display to the public (ex. Damaged disc that was received with book)

590 local note 10fixed field length use sparingly
edit volume display

if the title page and cover page are different --

245 title page primary source

246 difference cover title

590 local note 10 fixed field length. Use sparingly.

505 table of contents / contents

583 note when 505 added -- no 583 is needed if only deleting 856

583 BZ deleted 247 field. (kf 5/03)

583 GF deleted 856 field. (12/2006 nh)

Add

505 table of contents / contents

583 note when 505 added -- no 583 is needed if only deleting 856

583 BZ deleted 247 field (kf 5/03) does not print

583 GF deleted 856 field. (12/2006 nh)

856 remove Library of Congress table of content, pub description, etc links

863 MARC Holding [auto update next day]

866 award - notation

867 supplement

t.p. t.p.verso

Ask questions about major editing [especially the 245, 260, 300, 440, 490, 830] to BZ.

Title concerns (ex. Posttraumatic Stress Disorder

245 10 Posttraumatic stress disorder: malady or myth? / Chris R. Brewin

583 BZ corrected 245. (ST 3/2004)

650 0 Post-traumatic stress disorder.

Title concerns (ex. Posttraumatic Stress Disorder

245 10 Posttraumatic stress disorder: malady or myth? / Chris R. Brewin

583 BZ corrected 245. (ST 3/2004)

650 0 Post-traumatic stress disorder.

490 0# |a Pelican books

Series added statement

800 personal name

801 corporate name

811 meeting name

830 uniform title

4xx Series Statements - MARC - BLvl; m=monograph, s= serial

440 Series (traced as is)

If it has a number or year, that goes after : \$v.

490 Series (traced differently)

1st indicator, 1 in the MARC record means traced form is in 830. Don't use 490 0, untraced series; instead quote in 500, e.g. "Penguin books." A series with a subject world would be 440 or 490 1, without a quoted 500.

500 General notes

830 Series entered into catalogue differently than on item; Series as on item is in 490 1st indicator 1, and series as entered in the catalogue is here

830 Series added entry - uniform title - MARC

586 Awards notes -MARCTitle level

diacritic problems - correct as needed and add a note line for changes

SERIALS

If there is a change for a serial, use the 509 line for notes.

"When a serial displays a message in iLink that reads, "Invalid enumeration and chronology format", the error is in the MARC holdings field summary with an 863 used instead of 866 to display the beginning date of the run. The 863's are automatically created by the check-in's if you have 'update MARC holdings' checked, and if you put anything else into that field (like a summary) you will get that error message about 'invalid enumeration and chronology format'. Always use the 866 for that summary, and you'll never see that error message again." Jan Fandrich

WEAVER LIBRARY PROCEDURE MANUAL

Reserves Maintenance

Receiving

Physical processing

Checklist: Before You Can Add Reserve

Add Reserve

Temporary Item or Instructor's Material

Library Item

Instructor Not Found / Course Not Found

Deviations From One Faculty-One Class

Look Up in the Library Catalog (iLink)

Semester Update

Reserve Return Letter

Remove Reserve

RECEIVING RESERVES

Reserves are items that are in limited supply that instructors want to give their students fair access to. Check out times for reserve items range from two hours to seven days. This allows several students to use the item in a short amount of time.

When an instructor brings items to put on reserve, have him/her fill out the “MSU-Great Falls Library Request for Materials to be placed on Reserve” form. The forms are located in the grey 3-ring binder at the front circulation desk. It is important that it be filled out completely. We use the information on the form to catalog the item(s).

We ask that instructors give the library one working day to process reserves. We discourage situations where the instructor drops off items, and the students come asking for them that same hour. It takes time to do a thorough job cataloging reserves. Ideally, faculty should drop items off the day before they tell students about them.

RESERVES: PHYSICAL PROCESSING

Photocopies

When an item comes in, put a blank sticker on the upper right corner so it doesn't cover writing. Find a reserve folder that is not currently being used and verify that the OR# is one that is not being used for a book on reserve. Write the OR # on the sticker as in the following example:

OR 148

Stamp the item with the copyright stamp in a place where it won't obliterate information. Put the item in its folder.

Library's Items

Occasionally, instructors will place a library item on reserve. These items already have a call number that you don't want to obliterate. Use the "Removable Stickers" to label the item for the reserve shelf. **DO NOT REMOVE THE BARCODE...YOU CAN SIMPLY USE THE ORIGINAL BARCODE INSTEAD OF THE OR# BARCODE.** Make note on the request form that this item belongs to the library so that we make sure it stays here. Find an OR# in the Reserve Folder that is not being used. This is simply for the placement on the reserve shelf; we do not use the actual barcode. (Set it aside from others, indicating that the OR# is in use.)

Instructor's Items

Instructors bring in their own items for student use. In these cases, we make an effort to protect their things from the damage our stickers can cause. Use the "Removable Stickers" (located in the reserves processing drawer) to label the items. Find an OR# in the Reserve Folder that is not being used. Tape the barcode information to the upper left corner of the material. (Try to put most of the tape on our barcode instead of on the instructor's material.)

Information Slips

For each reserve we have started placing information slips on the material to remind students when the item is due and also to make them aware of the \$2.00 per hour/day overdue charge if the item is returned late. We also indicate if the item is "In Library Use Only" and any other special instructions for that item on this slip. Place these on the front of the books or videos and also on the front of the manila folders for the copied materials.

RESERVES MAINTENANCE--ADD RESERVE: FOR A LIBRARY ITEM

It is not necessary to add a brief title to a library item to temporarily place it in the reserve area.

In the Reserve toolbar....

Click on heading "Reserve Information"

Click on "Create Reserve"

Confirm both Reserve Desks have GF-RESV

Type in the item ID and click "Get Reserve Information" at the bottom of the page.

Enter the appropriate information according to the instructor's preferences.

Under the Basic Info tab-

Circulation rule: Select one of the following; 1DAYGF-RES, 2HRGF-RES, 3DAYGF-RES, 7DAYGF-RES

Expires (M/D/Y): enter the date of the last day of the semester the instructor specifies or "no date".

Status: Current

Under the Indiv Rsv tab-

Instructor ID: click the diamond to look up the instructor by

Last name. Ex: N300, MATH 150, etc... Math items are on 'permanent' reserve, so their Instructor ID is 1234 (MATH). Make sure the record is our GF-RESV record and not a record from another library.

Course ID: Click the diamond to look up the course ID. If the class is not listed or has a different course name, create a new course ID following the instructions under the "Reserve Maintenance Add Reserve Course Not Found" section on the following page.

Stage: Active (set for each instructor, if not previously set).

Under the Copies tab-

New Status for All Copies: On Reserve

New Status: On Reserve

Leave the other fields alone

Click "Create"

Click "Close" or "Another" if another is being added.

The location of the item will automatically adjust to RESERVES.

In the Cataloging toolbar.....

Click on "Titles" then "Modify Title" then click on the "Call number/item" tab. Change the Call Number to the OR #. You can use the Item ID# already on the material (less tape residue on the material). Make sure the current location is showing RESERVE. If not, go ahead and change only the current location, leave the home location field alone.

Click "Save". Now, the item is cataloged and on reserve.

RESERVES MAINTENANCE—ADD RESERVE: FOR A TEMPORARY ITEM OR INSTRUCTOR’S MATERIAL

I. BRIEF TITLE

Reserve items are temporary. They can be added or removed by the instructor on any given day. For this reason, reserve items get a brief entry rather than full cataloging

In the reserve toolbar...Item Info and Maintenance

Click “Add Brief Title.”

Enter an author, if there is one: Last name, First name (instructor’s name if applicable).

Enter the title of the item.

The call number is the OR# Ex: OR 163

Make sure “type,” “home location,” and “library” are correct. Approved

Types are: BOOK, VIDEO, PAMPHLET (for photocopies), CD AUDIO, CD ROM, PERIODICAL, NEWSPAPER, EQUIPMENT and CASSETTE.

The “home location” and “current location for reserve items is RESERVES.

The “library” is Great Falls

Enter the barcode in Item ID.

Click “add brief title” which is on the bottom of the page.

Now, you can either “Add Another brief title” or “Close.”

If there are additional copies needed, go to the “Cataloging” toolbar:

Click “call number and item maintenance”

Click “add call number”

Change info and click “save”.

II. ADD RESERVE FOR A TEMPORARY ITEM OR INSTRUCTOR’S MATERIAL

Adding a brief title is all the cataloging a reserve item gets. It is in Sirsi like any other item at this point. To make it a reserve item, you need to do one more step.

In the reserve toolbar...

Click “Reserve Information and Maintenance”

Click “Create reserve”

Click on the reserve item

Enter the appropriate information according to the instructor’s preferences.

Under the Basic Info tab-

Confirm the record is GF-RESV.

Circulation rule: Select one of the following; 1DAYGF-RES, 2HRGF-RES, 3DAYGF-RES, 7DAYGF-RES

Expires (M/D/Y): enter the date of the last day of the semester the instructor specifies or “never”

Status: Current

Instructor ID: click the diamond to look up the instructor, by last name, in the “Individual Reserve tab”.

Course ID: Click the diamond to look up the course abbreviation. Ex: Bio 107, MATH 150, etc...If the class is not listed or has a different course name, create a new course ID following the instructions under the “Reserve Maintenance Add Reserve Course Not Found” section.

Stage: Active (set this for each instructor)

Under the Copies tab-

New Status for All Copies: On Reserve

New Status: On Reserve

Leave the other fields alone

Click “Create”

Click “Close”

RESERVES MAINTENANCE-- ADD RESERVE: INSTRUCTOR NOT FOUND

Due to our new policy requiring adjunct faculty to present a faculty ID, if you are the one receiving the reserve request please make sure they have records in SIRSI already (including their Banner ID number). We are now doing banner uploads so we do not create the records ourselves. If the Instructor does not have an ID and/or is not in the system, please have them visit the payroll office and get their record fixed. **(Northern and Bozeman create their own Faculty Member IDs):**

We will process the materials for reserve once the faculty records are uploaded into SIRSI. The banner uploads take place Monday-Friday from 10:00am to 10:30am, so there may be a period of time before we are able to place the materials on reserve. Please see the Librarian if you have any questions or concerns.

RESERVES MAINTENANCE ADD RESERVE COURSE NOT FOUND

If the course is not available in SIRSI you can add it by following the following procedure:

Click "Course Information and Maintenance"

Click "Create Course"

Assign a course ID. Look in the current catalog to help you. Ex: Anatomy and Physiology I would be BIO 213. Since all of the libraries using SIRSI share the reserve course ID's there may be duplicates. Check to see if there may be a BIO213 (Without a space) with the same course name as we use. If so, use that Course ID rather than creating a new one.

Enter the course's name. In this example, it would be Anatomy and Physiology I.

Select "ALL" for the terms offered

Enter 100 for the number of students

Click "OK"

Click "Close"

Now you can return to the reserve window you left open. Enter the course ID where it is asked. Finish entering the reserve item as noted in the previous pages.

RESERVES: DEVIATIONS FROM ONE FACULTY, ONE CLASS RESERVES

Most reserves are one faculty putting items out for one of his/her classes. Sometimes, there will be variations to this norm. Possibilities include: one instructor, one item, two classes - or - two instructors, one item, one class - or - two instructors, one item, two classes etc...

Follow the instructions for “Reserve Maintenance-Add Reserve For Temporary/Instructor’s Material” or “Reserve Maintenance-Add Reserve for a Library Item” to get the item(s) cataloged for one class and one instructor. It doesn’t matter which class or instructor it is.

To catalog the item(s) for the second class and/or second instructor,
keep Sirsi on the reserves toolbar.
Click “Reserve Information and Maintenance”
Click “Add/Remove Individual Reserve”
Look up the intended reserve item
Click “OK”
Click “Add Instructor/Course Record”
Keep the same instructor or add a second one
Change the course ID to the second class (the one you didn’t catalog)
if necessary
Enter the proper expiration date
The stage is ACTIVE
Click “OK”
Click “Done”

RESERVES MAINTENANCE: LOOK UP IN THE LIBRARY CATALOG (iLink)

To insure that you have added the reserve items properly, look them up in the library catalog (iLink). Make sure that the patrons will be able to see the OR# and the circulation rules properly.

Go to the library homepage.

Under Find Books, Videos, Course Reserves Click the “Course Reserves” Link

Enter the instructor’s last name of the item you just cataloged. Hit “enter”.

Click the “course number” that you have just added materials to.

A list of that course number’s reserve items will display. Look it over to see if the new item(s) are there. They are listed in alphabetical order.

If the item is not showing up in the catalog, make sure the record isn’t being shadowed.

RESERVES MAINTENANCE: SEMESTER UPDATE

Reserve items are supposed to be temporary, so every semester, we start fresh in the library.

Certain items are 'permanent' reserve and the rest are temporary.

At the end of every semester, go through the "Library Staff Reserve Index" in the 'Completed forms' section. Look at the semester(s) on reserve segment. Permanent Reserves will say "Permanent" in the year. All others are temporary and must be removed at the end of the time specified on the completed form.

Ones that have expired must be removed from Reserves.

Be nice to the instructors and/or their secretaries by sending out an email notice a few days in advance of the Reserve purge.

Take the item(s) out of Sirsi. First remove the item from Reserve and then either delete the records completely or if it is a library material, change the call number back to original and change status to original location.

Recycle the barcodes by keeping the folders that hold photocopies. Their barcodes and OR#s can be reused. Store the saved folders and barcodes in the Reserves processing kit box (Located in the Reserve area). Remove all other Reserve related information from the item and return it to the instructor or library as appropriate.

Make adjustments to the form letter "Reserves Return Letter" (saved on the Library common drive folder under RESERVES. Be sure to adjust all the highlighted areas (make sure before you print it off however that they are all white again).

Instructor's items are returned to the instructor along with a photocopy of the completed form that lists the items s/he put on reserve. We keep the original and they get the copy along with their items. If an instructor had a library item on reserve, we note on their photocopy that the item was returned to the library collection. Include a blank request form with their pile of stuff so they can put things on reserve if they want.

Instructors can easily ignore a memo that lists their item(s), but they can't ignore the actual pile of materials. We ask that they reevaluate their Reserves at the date of expiration as noted on the sheet in the "Library Staff Reserves" folder. They can keep whatever they want, return the whole pile to us, add to their pile, or not return anything to us at all.

Put the original forms in the "Reserves returned to the instructor" binder, which is kept in the Library Tech's Office.

RESERVES RETURN LETTER

Include a letter like the one below when returning reserve items to instructors. This letter is in the Library's Reserve folder on the common drive. Change the highlighted elements as appropriate.

August 30, 2004

Hello from the Library!

Summer semester has ended and items that you placed on Reserve have expired. This is a pile of your expired Reserves.

Please review these items to see if they are still applicable to your syllabus, and are up-to-date.

You can either:

- 1) Keep all the materials
- 2) Return all the materials to the Library
- 3) Keep some materials and return some materials
- 4) Mix and match old materials with new materials
- 5) Etc...

I have included a blank form for you to be able to place items on Reserve for **Fall Semester 2004**.

Thank you for helping us prepare for the **Fall** Semester. If you would like to place **Fall** Semester Reserves in the Library, please give us a day to process them before telling your students about them.

If you have any questions, or if you want more forms, please don't hesitate to contact the Library.

Thanks again,

Your Contact Information

RESERVES: REMOVE RESERVE

When it is time for an item to come off reserve, it has to be taken out of Sirsi before the instructor can have it back. This is a two-step process on Sirsi. Step one takes it off reserve and step two takes it out of the catalog.

Reserve Area:

In the reserves toolbar...

Click "Reserve Information"

Click "ok" on GF-RESV desk screen

Click "Remove Reserve"

Enter the item's ID

Click "Get Reserve Info" at bottom of page

Click "Remove this reserve"

Click "Close"

If a Library item, go to part B.

If the item is NOT ours:

Title Area:

A. Temporary or Instructor's Materials

In the cataloging toolbar...

Click "Delete Titles"

Click "Delete Title, Call Numbers, or Copies"

This next part only works if you enter the title of the item.

Check mark the little box beside the item

Click "Delete" on bottom of page

A window with a "WARNING!" pops up

Click "Yes"

Click "Delete"

Click "Close"

B. Library Items

In the "Cataloging" toolbar ...

Click "Call number and Item Info"

Change the call number, current location, click "Save" Remove any Reserve markings and reshef. The Item ID should already be the original barcode, but check to make sure it is correct as well.

RESERVES MAINTENANCE—ADD RESERVE FOR A LIBRARY ITEM

For “Basic”, “Individual Reserve” and “Copies” tabs:

“Basic Information” tab:

The screenshot displays the 'Create Reserve' interface in the SirsiDynix Symphony WorkFlows application. The main menu includes 'File', 'Edit', 'Wizards', 'Helpers', 'Modules', 'Preference', 'Tools', and 'Help'. The 'Reserves' module is active, with sub-menus for 'Acquisitions', 'Cataloging', 'Circulation', 'Configuration', 'ILL', 'Offline', 'Reports', 'Requests', 'Reserves', 'Selection', 'Serial Control', and 'Utility'.

The 'Create Reserve' window features a sidebar with 'Common Tasks' and 'Reserve Information' sections. The 'Basic Information' tab is selected, showing the following fields:

- Identify reserve: [Text field]
- Item ID: 30967000384523
- Title: Clay : the history and evolution of humankind's relationship with Earth's mo... / Staubach, Suzanne.
- Desk: GF-RESV
- Placed: [Text field]
- Circulation rule: 2HRGF-RES
- Expires(MM/DD/YYYY): NEVER
- Copies needed: [Text field]
- Auto select copies:
- Status: CURRENT
- Keep copies at desk:

RESERVES MAINTENANCE CON'T....Catalog...Modify Title

The screenshot displays the 'Modify Title' interface of a library catalog system. The main window title is 'Modify Title'. The menu bar includes 'File', 'Edit', 'Wizards', 'Helpers', 'Modules', 'Preference', 'Tools', and 'Help'. Below the menu bar is a navigation bar with tabs for 'Acquisitions', 'Cataloging', 'Circulation', 'Configuration', 'ILL', 'Offline', 'Reports', 'Requests', 'Reserves', 'Selection', 'Serial Control', and 'Utility'. The 'Reserves' tab is active.

On the left side, there are several toolbars: 'Common Tasks' (Call Number and It..., Label Designer, SmartPort, Item Search and D..., Check Item Status, Help, Print), 'Titles' (Add Title, Modify Title, Duplicate Title, Delete Title, Call N...), 'Items', 'Authorities', and 'Special'.

The main area shows the title 'Clay : the history and evolution of humankind's relationship with Earth's most primal element / Staubach, Suzanne.' with tabs for 'Control', 'Bibliographic', 'MARC Holdings', 'Call Number/Item', and 'Bound-with'. The 'Call Number/Item' tab is selected, showing a tree view of holdings:

- TA455.C55.S73.2005 - GREATFALLS (selected)
- TA455.C55S73.2005 - BOZEMAN
- 31762104835150 - 1 - BOOK
- TA455.C55S73.2005 - CARROLL
- 3596200144525 - 1 - BOOK -
- TA455.C55S73.2005 - BILLINGS
- 33131006145993 - 1 - BOOK

Below the tree view, there are two columns of metadata:

Date created: 3/15/2006
Date last charged: 5/23/2006
Date due: none
Last discharged: 6/23/2006,7:57
Date inventoried: Never
Times inventoried: 0
Previous user ID: 801003125
Last activity: 6/23/2006
In-house uses: 0

Call number information:
Call number: OR 145
Class scheme: LC
Call library: GREATFALLS
 Shadow call number

Item information:
Item ID: 30967000384523
Copy number: 1
Type: BOOK
Item library: GREATFALLS
Home location: STACKS
Current location: RESERVES
Item cat1:
Item cat2:
Media desk:
Number of pieces: 1
Total charges: 1
Price: \$23.95
 Permanent
 Circulate
 Shadow item

Extended information:

Tag	Contents
CIRCNOTE	
PUBLIC	
STAFF	

RESERVES MAINTENANCE—ADD RESERVE: FOR A TEMPORARY ITEM OR INSTRUCTOR’S MATERIAL:

SirsiDynix Symphony WorkFlows

File Edit Wizards Modules Preference Tools Help

Acquisitions Cataloging Circulation Configuration ILL Offline Reports Requests Reserves Selection Serials

Add Brief Title

****REQUIRED FIELD****
XX(1500394.1) ID:1500394-1001

Title info

Personal Author:	100	1		Staubach, Suzanne
Corporate Author:	110	1		
Conference Author:	111	1		
Uniform title:	130			
Title:	245			Clay
Series Title:	440			
Subject term:	650			
Geographic term:	651			

Call number and copy info

New call number: OR 145

Library: GREATFALLS

Item type: BOOK

Home location: RESERVES

Item ID: 30967000384523

Item cat1:

Item cat2:

Common Tasks

- Reserve Session S...
- CheckOut
- Discharging
- Renew Reserve
- Receive Reserve
- Display Reserve
- Item Search and D...
- Check Item Status
- Create Request
- Help
- Print

Reserve Informati...

Course Informatio...

User Information a...

Item Information ...

Add Brief Title

RESERVES MAINTENANCE CON'T....."Copies" tab

The screenshot displays the 'Create Reserve' window in the SirsiDynix Symphony WorkFlows application. The interface includes a menu bar at the top with options like 'File', 'Edit', 'Wizards', 'Helpers', 'Modules', 'Preference', 'Tools', and 'Help'. Below the menu bar is a navigation pane with 'Common Tasks' such as 'Reserve Session S...', 'CheckOut', 'Discharging', 'Renew Reserve', 'Receive Reserve', 'Display Reserve', 'Item Search and D...', 'Check Item Status', 'Create Request', and 'Help'. The main area is titled 'Create Reserve' and contains a form for identifying a reserve. The 'Item ID' field is populated with '30967000384523'. Below the form, there are tabs for 'Basic Information', 'Individual Reserve', and 'Copies', with 'Copies' being the active tab. A dropdown menu for 'New status for all copies' is set to 'ON RESERVE'. A table below shows the current status of the reserve copies.

Copy >	Item ID	Home Locn	Curr Locn	Reserve Status
1	30967000384523	STACKS	STACKS	NOT ON RESERVE

RESERVES MAINTENANCE CON'T....."Individual Reserve" tab

The screenshot displays the 'Create Reserve' interface. At the top, there is a menu bar with 'File', 'Edit', 'Wizards', 'Helpers', 'Modules', 'Preference', 'Tools', and 'Help'. Below this is a secondary menu with 'Acquisitions', 'Cataloging', 'Circulation', 'Configuration', 'ILL', 'Offline', 'Reports', 'Requests', 'Reserves', 'Selection', 'Serial Control', and 'Utility'. On the left side, there is a 'Common Tasks' sidebar with icons and labels for: Reserve Session S..., CheckOut, Discharging, Renew Reserve, Receive Reserve, Display Reserve, Item Search and D..., Check Item Status, Create Request, Help, and Print. Below the sidebar is a 'Reserve Informati...' section. The main area is titled 'Create Reserve' and contains the following fields:

- Identify reserve**
Item ID: 30967000384523
- Basic Information** (selected tab), Individual Reserve, Copies
- Instructor ID: 801165144 | Stage: ACTIVE
- Course ID: SOC431 | Expires(MM/DD/YYYY): NEVER

WEAVER LIBRARY PROCEDURE MANUAL

Serials

- Checking in Serials in SIRSI
- Physical Processing
- Ebsco Claims
- Changes in Serials
- Creating Controls
- OCLC Holdings for YQY
- Weeding Introduction
- Weeding
- Serial Solutions
 - Add Title
 - Delete Title
 - Update Holdings

SERIALS: CHECKING IN SERIALS IN SIRSI

1. Click the upper left icon (labeled “Check in issues of a serial”) on the icon bar.
2. Choose **control ID** on the drop-down menu. Select the GF serial record using the control number format. (For GF that format is “xxx,xx,xx,”. That format is not unique to Great Falls records only!)
3. In the next box, type in the Control ID of the serial. Click the **OK** button or hit enter on the keyboard.

If all the information is correctly listed on the **Next Issue** tab, click the **Check in now** button.

If the predication information is incorrect, you might want to check the pattern before proceeding UNLESS the issue is a special issue. Don’t check in an issue if the prediction is wrong unless it is a special issue - otherwise, the old predictions will stay in the expected list and cause problems later.

If it is a special issue, click the “**Different Issue**” button and supply the needed information. Supplemental issues should include SUP after the date.

***There are other options available as well – if something does not seem right about your check-in, you might want to explore these other options or ask about it – don’t check in an issue if you are not sure it is being entered correctly.

4. If you need to correct the pattern (and predictions), you have to use the “Modify Control” icon. Use the “Generate Prediction for Expected Issues” button on the top bar of the serial record. If necessary, you can remove all predictions and proceed using the “Check in without predictions” option unless the issue sequence has been changed. There is the possibility have having different predictions for the same periodical at different times.
Check other consortium library serial predictions when the sequence is not clear.
5. When entering or modifying information, be sure to use standard Sirsi format:

V.|#|NO.|#

Use 3 letter abbreviations for the months and seasons

Date format is MONTH|year (DEC 2000)

or

MONTH|day,|year (DEC 4, 2000)

6. To complete the check-in, click the **Check in now** button.

7. Review the received list to double-check that your check-in is now on the list and note any missing or late issues. Missing/late issues should be noted on the month's serial worksheet list a notation that includes the volume/issue numbers and previous date claimed.

8. Make a note of any duplicates received on the month's serials claims form as well. Photocopy both covers of the duplicates or save the mailing envelopes and send to EBSCO.

SERIALS: PHYSICAL PROCESSING

- Property stamp in the following places:
 - Front Cover (if no address label present and if it's not glossy—
if the cover is glossy, inside the front cover)
 - Title Page with Contents
- Place a yellow dot on the upper left corner of the front cover, but avoid covering up dates, titles, and volume information. Since the newest issue of a periodical does not get checked out, we distinguish current with a blank yellow dot, and back issues with the date (or issue number) listed on the yellow dot.
- Security tag the magazine somewhere in the middle preferably between two white sheets. Try to select an inconspicuous spot like between two ads. Place the security tag into the gutter as far as possible. If you have difficulties, contact a Technician.
- Newsletter type periodicals do not need to have security tags attached.
- Shelf the most recent date on display racks. Mark the dot of the older issue with the date of the periodical. Shelf older dated issues in the plastic holders alphabetically by name and then date order on the periodical shelves in the back.

Some current periodicals are not on the display shelf. Shelf these issues directly in the containers on the back shelves.

SERIALS: EBSCO CLAIMS

The entire procedure for claiming should be completed before 4pm to allow for the EBSCO daily cut-off time. If the printing of the claims is not made before the cut-off, you will not be able to have printouts for our records.

1. Claims need to be compiled and submitted monthly. Use the last month's serials check-in sheet as your guide. Check any titles that are missing issues to determine if any claims need to be made for those. Once you have checked those titles, check the shelves just in case an issue has somehow slipped by. You will also want to have the information about the date of a previous claim to calculate the number of claims for a particular issue.
2. Claims need to be entered on the SIRSI serial control records for either missing journals or duplicates that have been received. While you can do this when you are missing issues at check in, it is best to do it as a part of the claims process so the claim dates correspond with the actual date you submit the EBSCO claims list.
3. Go to *Modify Control*. To create a claim, the missing/late issue must be on the list under the *Expected* tab (ie. predictions for the issue must exist). If the issue is not there, you will need to create a prediction for this issue. Then move to the *Claimed* tab and follow the steps to create a claim. Click *Create Claim*. Be sure to check the date of the issue, date claimed, and the reason for claiming.
4. Once the claims list is complete, claims should be made online at EBSCONET:

<http://www.ebsconet.com/login.aspx>

MSU-GF **customer code** is:

MSU-GF **user name** is:

MSU-GF **password** is:

Locate appropriate journal. Under "Links" you may view pertinent information about a volume/issue or information from the publisher. To make a claim, select *My Claims* on the bar under EBSCONET. the drop-down menu appears, select *New Claim*. Using the EBSCO serial number is best for the search. Select the appropriate order number. Use the *Claim this Order* button to display the journal. If the journal delivery has been regularly received with an unusual missed issue, you may order by using the underlined link titled *Available from Missing Copy Bank*. If you are making a normal claim and the volume/issue is listed under *Volume/Issue Information*, select the appropriate claim by checking the box under "Claim". Make sure the *Reason for Claim* is correct before clicking on the *Submit* button. In order to have a record of the claims made, you will need to select the *Reports/Claims Processed*, set the date range for that day and click *Request Report*.

If the issue is not listed, go to the bottom and enter in the missing issue information in the following format, V.XX NO.XX (YEAR MONTH and DAY), such as V.130 NO.3 (2004 SEPT 20). Each screen allows only for two claims and both claims must agree on the amount

of times the journals have been claimed. Make sure that the number of claims is set to the correct information. If an issue has been claimed before and still is not received, you can claim again by indicating the proper amount of times claimed and wait for 30 days between subsequent claims.

Claim type also needs to be specified. The default is “*01-Listed issues not received*” – this only needs to be changed if it doesn’t apply.

Duplicates are also entered on the claims list. Find the title as above but include the reference numbers from the mailing labels as well as the issue date in the **claim comment boxes**. Claim type will need to be changed to “*03-Duplicates being received*.”

Click the *Submit Claim button*.

5. EBSCO Claim Checkers maybe viewed online periodically and updated. Our customer representative is **Starla Covington**, Team Leader.

EBSCO
898 N Sepulveda Blvd
Suite 800
El Segundo, CA 90245-4469

Attn. Starla Covington

6. Claim checker reports, claims confirmations, duplicates reports, and a list of titles sent to the missing title bank should be filed in the EBSCO file drawer by month.

7. After completing an EBSCO claims/duplicate report, send that month’s duplicates to the missing copy bank. Address labels can be found in the processing folder at the work study desk.

EBSCO Missing Copy Bank
EBSCO Subscription Services
Box 830209
Birmingham, Alabama 35283

8. When claimed issues are received, go to the claimed tab to select the issue to be checked-in. Double check the record to make sure that the claim has been cleared.

SERIALS: CHANGES IN SERIALS

Missing Issues:

If an issue is missing or lost, the issue must be marked in SIRSI. In the *Serial Control* toolbar, select the *Modify Control* icon. Under the *Data Received* tab, find the issue, change the expected date to "NEVER" and make a note in the comments about the issue's status. (If the issue was never received, it will need to be checked in first before these changes can be made.) In the *Cataloging* toolbar, change the current location to missing so that it will be displayed properly.

Holdings Changes:

After a serials title change or anything that affects holdings information (dates, name, ISSN number, etc), that information needs to be updated. If there is substantial change, a new serial record must be brought over from Connexion Browser or created by Bozeman before making a new serial control. Updating serial control information is a 3-step process involving both the serial control area and title information area.

1. (BE SURE TO CHECK THAT YOU ARE IN GREAT FALLS RECORDS ONLY!) In the *Cataloging* toolbar, select the *Title Maintenance* icon, then *Edit Item* icon. Find, verify periodical title and modify the record with the needed change.
2. In the *Serial Control* toolbar, select the *Modify Control* icon. After locating and verifying the proper serial control record, change the correct information.
3. Any changes in serials holdings, such as titles added, title changes, dates retained, etc., need to be reflected in the Current Serials List or the Serials Claims List.

Purged titles:

Removing an entire serial control holding should be performed in June between the school calendar year. Before making any corrections, evaluate the complete holding in all aspects.

In the *Item Search and Display*, check all items to see if any have fines or holds attached. If there are any items that have fines still attached (holds, etc.), the title will not be removed. At this point, you need to evaluate if it is a situation before Library Policies were in effect. If it is prior to that time and the fine is a minuscule amount, remove the fine (remove the antiquated patron record) and then delete the record. Any questions about how to continue should be reviewed with the Head Librarian for determination on how to proceed. If the fine should not be removed, do not proceed until the record with removing the record until all fees have been rectified.

Then check under *Maintain Existing Titles* by typing in the name of the holding with *Great Falls* as the library to access any duplicate or unusual circumstances.

Next, check *All Libraries* records for the holding (check MARC holdings, etc) under *Display Serial Control*. Older holdings will have a wide variety of unusual situations. (*Note: Serials that were last received before 1997 will generally not have a serial control.)

1. First, look up the appropriate serial in *Item Search and Display* by using *All for the library* to evaluate the present record. If there is another consortium library with holdings for the serial, only remove the Great Falls items but leave the title intact. If it is determined that only Great Falls has holdings for the serial, delete the entire serial control using the following process. (Be sure to select only Great Falls records because it is easy to delete or alter other consortium serial records.

2. Go into **My Computer/Common Drive/Library/Serials/Serial** claiming worksheet. Correct the information on the affected serial in the worksheet. In the **Discontinued, Removed or Additions folder**, find the appropriate current year list for serials changes. Enter the Title, ISSN#/s, dates of volumes removed

3. In the *Remove Title, Call Number, or Copies* button, remove Great Falls titles only. One record will not remove because of a serial control, "**The following could not be removed. Title Under Serial Control**". Click *OK*.

4. In the Series Mode, go to *Modify Control* and type in the name of the serial using Great Falls for the location. Remove the following tab information in the order as displayed being sure to save after every action.

1) Under the *OPAC Display tab*, change the issues display from "4" to "0" 2) Under the *MARC Holdings tab*, bring up information for GF and remove the 599 field, then remove the *Marc Holding bar* record for Great Falls, 3) Under the *Subscription tab* – change copies to receive "0", 4) Under the *Distribution tab* – change expect "0" & add "0", 5) Open the *BIB tab* to check the BIB record for GF and correct the 599 field. Modify the field by changing only the Great Falls records which are indicated by "3". Highlight the issues affected and click the *DELETE button* in the upper right hand corner

5. In the *Title Mode*: In the *Cataloging toolbar*, select *Title Maintenance*. Check the MARC holdings to see if any record exists for GF (none should appear). Then proceed to the *Remove Title, Call Numbers or Copies* and remove titles for Great Falls. Find the periodical title pertaining to Great Falls, verify, and remove with *Remove Selected Copies*. One record will not remove because of a serial control, "**The following could not be removed. Title Under Serial Control**". Click *OK*.

If the removed serial is held by another library in the SIRSI system, you need to go to *TITLE MAINTENANCE – Modify* to correct the record connected to MSU-GF. **Line item 599** that is listed as "3" is for Great Falls and should be deleted. Go to the Library Catalog to verify that the record for MSU-GF is completely removed.

The **596 field** should automatically update the next work day. You can verify this information through the Library Catalog. If you do need to adjust the field, go to *Modify Control* and verify the selection is the appropriate serial. In the upper right hand corner,

use the *Modify Bibliographic Description* button to bring up the appropriate information to correct.

6. In Series Mode: Under *Modify control*, remove copies in the following order- Claims, Received, and Predicted. Under Remove Control, remove (if other libraries have holdings for that journal, be sure to remove GF records only!) affected records. In **serials** toolbar, select the *Remove a Serial Control* icon. Find and verify the record. Click on the *Remove* button.

7. In the Title Mode: Remove the journal by typing in the name of the journal and entering in Great Falls. There will be a warning about removing a title. This message will only appear if that is the only library consortium record. Click *OK*. Return to **cataloging** toolbar, find and verify the record making sure you are affecting only Great Falls records. Select *Remove Title*. You will be asked if you want to remove the title; select *Yes remove title*. If other libraries are holding this title, check to see that all records for and only for Great Falls information have been purged.

8. Remove from YQY record in Cat Express. Go to Cat Express. Look-up the serial by the ISSN number and verify information. Check if the serial is held by YQY. Verify information and click on *Delete Holdings*. You will be asked if *you want to delete OCLC "YQY" for record (serial title)?* Select *Yes*. (Note: Only make deletions in Cat Express if no additions that will occur that day.)

Titles still in stacks but subscription ceased:

1. Change the information in the control (using the *Modify Control icon*) from *active* to *ceased*.
2. Change holdings records (under *Modify Title icon*) so that the information is correct in WebCat.
3. Change the MARC holding information and any pertinent bib information.
4. Go to the Serial Worksheet in the common drive for the Library. Remove the Bold feature for the Serial control to indicate that the serial is not a current holding.

Holdings Changes:

Any changes in serials holdings– titles added, title changes, dates retained, etc. – need to be reflected in the **Current Serials List** maintained for patrons and in the **Serials Claims List** maintained for us.

SERIALS: CREATING CONTROLS

A. Attaching a serial record – for periodicals already in the system from another OMNI library

1. Search for the item by periodical title using *ALL* Libraries in the Display option. Select the appropriate issue from another consortium library holding.

2. In the cataloging toolbar, choose the correct title. Select the *Add Volumes and Call Numbers* icon. Be sure to indicate that the new record is Great Falls.

3. Add a “dummy” item to the list by adding a volume and call number to the current item:

Library = GF

Call # info: New call # = PER

Class scheme = LCPER

Barcode=AUTO

3. In the serials module, open *Create a Serial Control*

Library = GreatFalls

Holding code = GF-PER

*if attaching a record, find the title using search (must enter title; don't choose “current”). A message will appear saying “This title already under serial controls” – from the list of options, choose *Create a New Serial Control*.

4. Complete the needed information under each tab:

Control ID = use 3,2,2,1, coding pattern

Status: Active/ceased/discontinued?

SISAC ID = ISSN #

Category 1= GENERAL, if an Ebsco title
= OTHER, if not Ebsco

Vender title #: EBSCO

Category 2 = PERIODICAL

Base call number = PER

Class scheme: LCPER

Subscription ID (if EBSCO) = dv1100004ab#####

The only time you change the control ID format is for a situation like for, already being used for Forbes so you would use fort, for Fortune.

Patterns tab: if the MARC record was imported, patterns should be there and you will want to verify them against information in the periodical. If you did not import a record, you will need to develop a pattern yourself from the information in the periodical.

OPAC Display: “Automatically update MARC holdings” should not be checked. “Display the” [4] should be indicated. “Both” (Chronology & Enumeration) should be on.

MARC Holdings:

Add button

852 = |cPERIODICAL

866 = |aCurrent 5 years, if applicable

= |aV. _#_(year)- example |aV. 6 (2000)-

Subscription: **At this point, this needs to be figured out and added later

Distribution:

Copies to add to catalog = 1

Update MARC holdings records should not be checked

5. Once all this information is completed, select the “Create Control” button. You will then be prompted to complete prediction information under the Expected tab.

6. After you have created your control, go to “Title Maintenance,” then “Remove Title.” After finding the title, find the dummy record in the All Volumes list and delete it.

B. Creating a new serial control from an imported record

1. Using CatExpress, find the appropriate record and download a MARC record(s) using periodical. Be sure to bring the record over as a serial.

2. Add the MARC record(s) into Sirsi. Again, follow the instructions outlined for this under cataloging in the procedure manual, with these changes: when *scheduling the GF Batch Bibload Books report*, under the selection criteria tab, change the default holding code to “GF-PER” and switch to the serials toolbar, not the cataloging toolbar, after you’ve viewed your report.

3. In the serials module, open *Create a Serial Control*.

Library = GreatFalls

Holding code = GF-PER

*if attaching a record, find the title using search (must enter title; don’t choose “current”). A message will appear saying “This title already under serial controls” – from the list of options, choose *Create a New Serial Control*.

4. Complete the needed information under each tab:

Basic tab:

Control ID = use 3,2,2,1, coding pattern

Status: Active/ceased/discontinued?

SISAC ID = ISSN #

Category 1= GENERAL, if an Ebsco title
= OTHER, if not Ebsco

Vender title #: EBSCO

Category 2 = PERIODICAL

Base call number = PER

Class scheme: LCPER

Subscription ID (if EBSCO) = dv1100004ab#####

Patterns tab: if the MARC record was imported, patterns should be there and you will want to verify them against information in the periodical. If you did not import a record, you will need to develop a pattern yourself from the information in the periodical.

OPAC Display: “Automatically update MARC holdings” should not be checked. “Display the” [4] should be indicated. “Both” (Chronology & Enumeration) should be on.

MARC Holdings:

Add button

852 = |cPERIODICAL

866 = |aCurrent 5 years, if applicable

= |aV. #_(year)- example |aV. 6 (2000)-

Subscription: **At this point, this needs to be figured out and added later

Distribution:

Copies to add to catalog = 1

Update MARC holdings records should not be checked

5. Once all this information is completed, select the *Create Control* button. You will then be prompted to complete prediction information under the Expected tab.

6. Check WebCat the next day (it takes a day for the record to appear). Review and make any changes necessary, such as removing the initial “PER”-only record (see #6 under attaching a serial record).

7. You might need to do title maintenance after you’ve finished. Check Webcat the next day, review and make changes or go to title maintenance and change the vol/copy information (see #6 under copy cataloging a new serial control).

C. When no serial control is found

If you can’t attach an appropriate record, contact the Jan Fandrich MSU-Billings for the correct procedure to perform original cataloging for serial publications.

Update holdings in <http://connexion.oclc.org/> under the *Cataloging* tab. This allows other libraries to view our holdings.

Questions on serials can be directed to Jan Fandrich (jfandrich@msubillings.edu).

SERIALS: OCLC HOLDINGS FOR YQY

How do I update the holdings for serials?

1. Log onto Connexion at <http://connexion.oclc.org>
 - a. Authorization:
 - b. Password:
2. Click Search
3. Type in the ISSN or the OCLC number in the first box under keyword/numeric
4. Change the drop down menu beside this box to appropriate search
5. NOTE: Make sure the box beside SHOW LOCAL HOLDINGS IF SINGLE RECORD IS FOUND is checked.
6. Find the correct record. (Hint: Look for LH beside the number. These are the records that we have updated.)
7. Click on the number
8. Make any necessary changes to the local holding. You can click the + sign beside each field to see a menu that explains what the different things are.
9. Click the downward pointing arrow beside Action.
10. Click Replace Record.
11. Click OK

The system automatically validates the record to make sure everything is correct. If you get an error message, you will need to make changes to the record until the errors are cleared. Within each field, OCLC has a link to a website that explains what the field means.

The proverbial second way to update holdings

1. Log onto Connexion at <http://connexion.oclc.org>
2. Click Search
3. Search for item
4. Find the correct record
5. Click on the record number
6. Click the downward pointing arrow beside Edit Local Holdings Records
7. Click Apply Default CD
8. Click the downward pointing arrow beside Action
9. Click Replace Record
10. Click OK

So what is a Default CD?

CD stands for Constant Data. This is a record that we created, because so many of our serials follow the same format. The dates may change, but we keep our serials for 5 years. We created a record that has this default information as well as information about our lending policies. You can apply the default CD to save yourself some time, but make sure that the dates are correct.

How do I add holdings for a new serial?

1. Log onto Connexion at <http://connexion.oclc.org>
2. Click Search
3. Search for the item
4. Find the correct record
5. Click the number beside the record
6. Click the downward pointing arrow beside Action.
7. Click Create Local Holdings
8. Delete the 853 and 863 fields
9. Click the downward pointing arrow beside Edit Local Holdings Record
10. Click Apply Default CD
11. Change the dates
12. Click the downward pointing arrow beside Action
13. Click Add Record
14. Click OK

How do I delete holdings?

1. Log onto Connexion at <http://connexion.oclc.org>
2. Click Search
3. Search for the item
4. Find the correct record (HINT: look for LH beside the number)
5. Click the downward pointing arrow beside Action
6. Click Delete Local Holdings
7. Click OK
8. It will ask you if you want to delete your institution's symbol. Click Yes.

SERIALS: Weeding Introduction

Our library is small in area and instructors want students to have the latest information, so we weed the serials at the beginning of every calendar year.

Generally, anything older than five years is removed from the collection. Do not remove any journal issue that combines the last issue in December and the first issue in January even if it is dated older than 5 years.

In advance of the purge, e-mail notices will be sent out to faculty/staff with priority to individuals / departments that have an educational interest in a particular journal. The e-mail should list selected journals and state something like, "We are removing all (year) journals/magazines from the Library shelves. Please let us know if you would like to have any particular titles set aside for you." The journals/magazines are given out on a first come-first served basis.

Work-study students can go through each journal container on the shelves and remove the appropriate year to be weeded.

Removed issues must be deleted from the Serial Control and Title Maintenance before processing for discard.

The work-study can remove/black-out any property markings, stamp as discard, and desensitize issues that have been weeded.

Any journals that are not claimed may be re-cycled.

SERIALS: WEEDING

Periodical Collection

According to our Collection Development Policy, we maintain back issues of most of our periodicals for five years. This means that once a year, we must weed the periodical collection of the older issues at the end of December or early January.

In advance of the purge, send out e-mail notices to (1) pertinent faculty (subject content), relevant department, or (2) to all faculty or everyone to find out if there is interest in taking the back issues after the removal processing is complete.

Check each serial to be weeded. If the weeded issue is a combined issue that overlaps two years (ex. Dec/Jan issue), retain the issue in the stacks but recognize/record the issue as “current 5 years”.

Go to the Serials toolbar.

1. Click the *Modify A Serial* button
Using Great Falls Library, type in the control ID of the appropriate serial.
Select the *Received tab*
Click *UnReceive Issues* at the bottom of the panel
Select the appropriate issues that need to be weeded
Click *Remove*
Next go to the *Expected tab*
Click *Remove Predictions*
Select the appropriate issues that have been weeded
Click *Remove*
2. Click the *Check-In Issues button*
Type in the Control ID of the appropriate Serial using Great Falls
Select *MARC Hldgs tab*
Click on the *GREAT FALLS – PERIODICAL – bar*
Correct the 866 Field to reflect the serial issues on hand

To take journals out of SIRSI, use the cataloging toolbar. **Be careful to not change the default (*Remove Selected Copies*). Check closely that only Great Falls copies are selected. It is easy to remove other consortium records at this point.**

Click *Title Maintenance*

Click *Remove Title, Call Numbers, or Copies*

Make sure the window is asking for a search by Periodical Title in Great Falls

Enter the title of the serial and click *OK*

Click *Remove*

Look through the list and ‘check’ the appropriate issue(s) on the right hand side of the window

Click *Remove*

Click *Remove Another Item* or *Close*

E-mail a corrected holdings list to Serials Solutions.

Update any necessary periodical holdings changes in Connexion to indicate current local holdings. Contact Serials Solution by e-mail with the correct holdings information.

Re-label journal containers as necessary. Current serial lists also need to be updated at this time to reflect any changes in our holdings.

On each issue remove all library markings, desensitize, and on the front cover/title pages stamp "Withdrawal".

Newspaper Collection

According to our Collection Development Policy, we retain back issues of our newspapers for two months. At the end of each month, old issues need to be pulled and recycled.

Some faculty/staff members ask for back issues. Currently, we notify:

Jon Nitschke - Wall Street Journal

SERIALS: SERIAL SOLUTIONS

What is it? Serial Solutions is the vendor that connects our electronic databases and print holdings. It lets users know where to find full text information. It also lets users know which database indexes a particular journal. It is linked on the library page as the Full-Text Finder.

How does it work? We work with the company to update our print and electronic holdings. At least once a year (usually more often), we send the company a listing of all of our print holdings and the dates of the holdings. We also notify the company of any changes, additions, or deletions in our electronic databases.

How do we send updated print holdings information?

1. Open the Serials folder
2. Open the Serials Solutions folder
3. Open an adjusted copy spreadsheet. (The latest list is probably the best choice.)
4. Make the necessary changes. Add any new titles. Delete old titles. Change dates.
5. Save the document as AdjustedCopy YQY-UZH-“MonthYear” (Simply use the current file name structure, but change the month and year.)
6. Send an email with the most current spreadsheet attached to clients@serialssolutions.com

How do we notify Serial Solutions of electronic database changes?

- Send an email with changes to clients@serialssolutions.com
- OR-
- Make the changes in the client center

What is the client center? It's an online website where we can

- Manage changes to our holdings
- Change the way the Full-Text Finder page looks
- Run statistics to see how well the product is used

How does the client center work? The Senior Librarian must work with Serial Solutions to give other staff members access to the client center. Once this happens, the staff member can use the client center.

1. Log onto <http://clientcenter.serialssolutions.com/>
2. Type in your username and password (Serial Solutions will send this information to you once you have been set up as an administrator)

What's in there?

- Data Management Home - lets you make changes to our serial holdings
- E-Journal Portal Customizer - the place where you make changes to how the website looks
- Usage Statistics - find out how often the full-text finder is searched and how often users click through (ie. How many of them find their way to the article?)

How do I add a database?

1. Search for the database using the search box at the top of the page.
2. Click on the database name
3. Click on the arrow beside not tracked
4. Change the text to subscribed
5. Place the URL to access the database in the custom URL box. This URL will include our proxy in front of the database URL. As an example here is the URL for InfoTrac OneFile:
http://proxygf.lib.montana.edu:2048/login?url=http://infotrac.galegroup.com/itweb/mtlib_a_gf?db=ITOF
6. Click Save Changes

How do I delete a database?

1. Click on Data Management Home
2. Click on the database you wish to delete
3. Click on edit.
4. Click on the arrow beside subscribed
5. Change text to Not Tracked
6. Delete URL from custom URL
7. Click Save Changes

How do I customize the Full-Text Finder page?

1. Click on E-Journal Portal Customizer
2. Click on Edit beside the area that you wish to customize.
3. Make changes.
4. Click Save Changes
5. Click Preview E-Journal Portal to see what the page will look like

When do the changes appear? Note that all changes (additions, deletions, corrections, etc.) take **24 hours** to appear. Changes made on a Friday will appear the next business day.

How do I run reports for statistics?

1. Click on Usage Statistics
2. Use the boxes at the top to change the time frame.
3. Click on Click-Through Stats to see the number of times that users have followed a link to an article.

Who do I call for help? Serial Solutions is very helpful and friendly. Here is the contact information:

Email: clients@serialssolutions.com
Toll-free: (866) SERIALS (737-4257)
Telephone: (206) 545-9056
Fax: (206) 525-9066
Hours of Operation: Monday - Friday, 8am to 6pm PST

WEAVER LIBRARY PROCEDURE MANUAL

Interlibrary Loan (ILL)

- Patrons

- Local Availability

- OCLC ILL/Firstsearch

- Borrowing

 - Clearing Customers

 - Requesting on Illiad

 - Processing (Ordering OCLC) Borrowing Requests

 - Copyright Compliance

 - Receiving *Non-Returnable* Interlibrary Loans

 - Receiving *Returnable* Interlibrary Loans

 - Examples and Addenda

 - Return Interlibrary Loans We Borrow (Returnables)

 - Renewal Requests

- Lending

 - Lending Policy Overview

 - Processing ILLiad Lending Requests—Searching the Catalog

 - Changing Loans to Articles and Vice Versa

 - Manual Input of Lending Requests

 - Printing ILLiad Lending Pullslips

 - Updating ILLiad Lending Stacks Searching Results

 - Printing Address Labels and Invoices

 - Checking Loaned Items In and Answering Renew Requests

- Ariel

 - Sending and Receiving Ariel

 - Examples

 - Ariel 3.0 User's Guide

- Overdues

 - Interlibrary Loan (ILL) Overdue ILL

INTERLIBRARY LOAN (ILL) PATRONS

Interlibrary loan (ILL) is a service we provide to help students and faculty/staff with their learning or teaching needs. Our library has a limited collection, so on occasion, we ask other libraries to lend us their materials for our patrons.

The cost to us of a single ILL (\$20 +) and all of the involved paperwork leads us to limit this service to students and faculty/staff members.

Community borrowers are asked to use the public library for their ILL needs.

MSU-Northern and MSU-Bozeman students on this campus are asked to go through their own libraries since patrons are only allowed to have one account in ILLiad. If special circumstances arise, please ask the head librarian on this matter. Otherwise, please refer them to their library's home page.

The person who is processing the Interlibrary Loans will make sure the patron is a student, staff, or faculty and has a valid account in SIRSI. If they are in SIRSI as a STUDENT or FACSTAF, go ahead and start working on the request. **Watch out for COURTESY patrons in SIRSI. COURTESY means they are a community borrower, and must use the public library for their ILL requests.**

If they are not in SIRSI, they will have to be entered. If the requestor is still there, have him/her show a valid student ID and enter them into SIRSI. If they are not available, call them and explain they have to be in the library computer as a student or a faculty/staff member before we can process the ILL request(s).

INTERLIBRARY LOAN (ILL) CHECKING FOR LOCAL AVAILABILITY OF ITEM

After receiving an interlibrary loan (ILL) request, the first priority is to check for local availability. Items that are available in Great Falls are not borrowed through ILL. The requestor is asked to visit that library to obtain the needed material. Exceptions are made for public schools, Malmstrom AFB, and the McLaughlin research center. These libraries are not accessible to our patrons (except military personnel can access the Malmstrom library).

Here are the places to check before making an ILL request: our library catalog, the UGF library catalog, the Great Falls Public Library (GFPL) catalog, the E-Journal source finder, the yellow "Great Falls Libraries Magazines/Journals list", and the large black "Benefis Journal/Video List" binder.

Our library catalog, the UGF library catalog, the GFPL catalog, and the E-Journal source finder are all available from the library web page. Click "Other Libraries" to access UGF and GFPL.

We now have our own Full-Text Finder to find available online journals. Click "Indexes and Databases" at the top of the home page, then select "Full-Text Finder" to see if journal or newspaper articles are full text on the computer. Enter the journal or newspaper title and click "Search." If that journal or newspaper is full text on the computer, verify that the requested article is full text.

If the item is available locally or on-line through "Full-Text Finder" or one of our databases, we can then cancel the request. In ILLiad, Borrowing, click on the request and click "cancel" from the tool bar. Click on one of the radio buttons, or click "other" and type in the reason for cancellation in the bottom bar provided. Click "cancel", and the request will cancel and disappear. Then "refresh" on the main page.

Interlibrary Loan OCLC Firstsearch

Currently we are using the ILLiad system as our preferred way for requesting ILLs.

After checking for local availability of the item, log onto the ILLiad Client. You should have your own name and password to use. New staff members may be added through the ILLiad User Manager by just typing in the person's first name in the "Add User to System" area in the upper right hand corner. The default password is "ill".

For further assistance in using the ILLiad modules you can access the support website at <http://www.atlas-sys.com> or call the help desk at 800-848-5800.

This system is hooked up with the OCLC Firstsearch. If in doubt, after you are finished processing the materials in ILLiad, you can double check the status in Firstsearch. You can bookmark the address on your office computer if need be. You can also set up the authorization # and Password to automatically remember your information.

Web Address: www.firstsearch.oclc.org

Authorization #:

Password:

Please remember that this service does charge for the amount of time, number of searches, number of requests sent, etc. Keeping this in mind PLEASE have all your information ready when you log in and start searching for the materials requested.

When using the OCLC-Firstsearch, it is important to use the commands within the program. You cannot use the buttons given by the browser. The EXIT button is located at the top right hand corner of the website. Remember to "exit" properly; otherwise, it could take up to 30 minutes to log off our account, thus charging us with a lot of unnecessary costs.

If there are any further questions that we cannot answer, please contact Ann Schwab at BCR.

For non-emergencies

aschwab@bcr.org

Fax #: (303)751-9787

For emergencies

1-800-397-1552 ext 108

(303)751-6277 ext 108

Mailing address:

14394 East Evans Ave

Aurora, CO 80014-1478

Clearing Customers

When new users register with the system via the ILLiad web pages and need to be cleared by the ILL staff, a new Clear New Customers icon will appear on the ILLiad Main Menu just below the Refresh Button. To clear or disavow new users, follow these steps:

- Select Clear New Customers from the Pre Processing menu or click the Clear Customer Icon on the main page.
- The Clear or Disavow Customers screen will appear. The screen is broken down into three sections. The top left section has a list of names for customers who need to be cleared. The bottom left section is the detailed information for the selected record. The list on the right shows user records currently in the database based on the user that you've clicked.
- Select a customer to clear from the menu on the top left side of the window by double clicking on a name. The customer's information will show in the Customer Information fields at the bottom left side of the window.
- Check the customer's information to verify the customer can be cleared to use Interlibrary Loan services we provide. Verify that the customer has not registered with ILLiad by checking the list of names on the right side of the window. You also need to verify that the patron is a current student by checking banner and making sure they have a record in SIRSI. Also, check to see if they **ONLY** have their Banner ID # in the Customer Information block. Anything else is not valid. The customer has to make the change, if any other information is in this block.
- **Clearing Customers** - After verifying the customer's information is correct (or correcting it as needed), click the Clear Customer button. Any changes made to the customer's information will be saved when the customer is cleared. The cleared customer will receive an automatically generated E-mail welcoming him/her as an ILLiad user.
- **Disavowing Customers** - If a customer is not affiliated with our institution or has been entered twice, you have the option of disavowing the customer by clicking on the Disavow Customer button. An information window will open verifying that the customer is to be disavowed. An information window will open with a field to provide information to the customer. In this field, explain why the customer has been disavowed. Then click the OK button. The disavowed customer will receive an automatically generated E-mail explaining why he/she was denied as an ILLiad user.
- **Disavow/Merging Customers** - If a customer name appears twice in the list on the right of the Clear or Disavow Customers form, you can disavow or disavow/merge one of the usernames. To merge two usernames, you must select each customer record and Send them to the Merge/Disavow form.
 - First, select the username you want to get rid of by right clicking on it (in either list) and choosing Send to Old User (Merge Form).

- Next select the username you want to merge into by right clicking on it (in either list) and choosing Send to New User (Merge To).
- Click the Disavow/Merge button. You will be shown the Merge Customer Review Form. This will merge the two records together under the new username.
- The form will show the old username and the new username, along with their information. If this looks correct, click on the OK button to merge the two usernames into the New User. This will also take any requests listed under their old user account and move them to the new account.

UPDATING PATRON RECORDS -

Once a patron signs up for an account and can't remember their username or password, you can look up their information and reset their password in the **Borrowing Module** of ILLiad. The patron CANNOT change their username once they have signed up for an account. They are free to update their personal information and change their password, email, address etc. from their ILLiad account.

TO SEARCH FOR PATRON'S INFORMATION:

Click **Edit** from the drop down menu

Select **Edit Customer**

You can then do a search under the patron's last name. To get the patron's information to populate the customer information fields, you need to double click on the patron's name from the list on the right hand.

TO RESET PASSWORD:

Once the patron's information has populated the customer information fields on the bottom half of the screen, you can simply click the **Reset Password to ill** button on the right hand side.

Requesting on ILLiad

We have set up a new account for requesting information from MSU-Bozeman, MSU-Billings, and MSU-Northern Libraries. If you have looked in the card catalog to see that any of these libraries own the item, and it's within their lending policies please use ILLiad to request the information. This system does not cost our library anything where as OCLC has numerous charges with each ILL produced. One thing to remember when using ILLiad to borrow is that it will not be forwarded on to other lending libraries. So make sure it is something that is able to be loaned before processing.

To use these services, please follow the instructions below:

MSU-Bozeman Libraries' home page at <http://www.lib.montana.edu>. On the left side, hover the cursor over Interlibrary Loan, then on the right side, click on the top line "Interlibrary Loan (ILL) Request Form". Near the top there is another link that will take you to the "Other libraries requesting items from MSU-Bozeman". Click that link and enter in our information.

Enter our ILLiad Username, which is:

Enter our ILLiad Password, which is:

If you have any questions please contact MSU-Bozeman.

For MSU-Billings and MSU-Northern, you can just put their OCLC symbol in the lending string and finish the request. Since this is considered local access, it will not go through OCLC. Since this is going through the local networks, you can put both OCLC symbols in the lending string if both libraries own the item.

PLEASE REMEMBER TO EXIT THE ILLiad SYSTEM WHEN YOU ARE FINISHED!!

Processing (Ordering OCLC) Borrowing Requests

- On the borrowing module you typically should not have to download anything to have the requests show up, as long as patrons use the ILLiad link on the home page the requests will automatically be forwarded to the correct folder.
- Click on **Awaiting Request Processing. (For “Awaiting Copyright Clearance”**copyright guidelines please follow the steps listed on the next page).
- Click on the request. Then, log into “Worldcat” in OCLC and retrieve the requested item information. Edit the request with the OCLC Accession #, and/or the ISBN/ISSN #'s, and **Save Changes**.
- Click on the OCLC button in the upper right hand corner (This will automatically log into OCLC)
- You can either go to the drop down menu under Searches OR click on one of the hotlinks from automatic searches from the bottom (It's a lot easier and more convenient to pick from the automatic searches. Make sure you have either the OCLC Accession # or the ISSN/ISBN # in the request before you go searching.)
- Click on the “**Holdings**” menu, then “**Custom Holdings**”. Choose “FreeV, “LVIS Ariel” or “Unions”. If one doesn't have enough lenders, go to another. If you don't want the symbols that are created automatically, double-click on the symbol of your choice to put it in the lender string on the right hand side.
- After the five (or fewer if that is the case) symbols have been chosen, click on “**Create Work Form**”. Confirm all of the information on the page and click “**Send Request**”. Click on “**Request Sent**” on the next step/page.
- On the main page, “**refresh**” and the system automatically moves the request to “**Request Sent**”.

Copyright Compliance

This is important when requesting magazine articles. A responsible lender won't even send the material, unless the borrowing library has indicated that it has complied with copyright. When requesting an article, the borrowing library should indicate whether or not it complies with CCG or CCL. So what are these?

CCG - Complies with Copyright Guidelines

- Applies to journals, magazines, etc. that have been published **within the last five years.**
- Can only have five filled requests from the current five years of a copyrighted title within a single year. This is without paying a copyright fee. You can request more copies, if you pay the fee.

CCL - Complies with Copyright Law

- Applies to journals, magazines, etc. that are **older than five years.**
- For replacement copies, if an item is out of print and cannot be obtained at a reasonable price, an entire work can be copied by the lending library.

Responsibilities of borrowing library with regard to copyright

- Display copyright warnings
- Comply with Copyright law when making requests for photocopies
- Retain records of requests for copies for three years plus the current year

Responsibilities of lending library with regard to copyright

- Return borrowing library's request if copyright compliance is not indicated
- Include notice of copyright requests for photocopies

Receiving *Non-Returnable* Interlibrary Loans

After opening package keep all information together (i.e. boxes, envelopes, loan item, paperwork), until you are ready to process the materials.

- Click on **Receives** and select **Check Item In**.
- Type in the Transaction# (If there is no TN#, you can do a search by using the OCLC ILL#, Article Title, etc.) and hit **Search**.
- Verify that it's the correct information for the item/record.
- Click on the radio button to tell us which library actually loaned the item.
- If all information is correct, you may check the item in. When you have finished checking in all the requests we received, go back to the main menu and click on the **Refresh** button (the little clock on the left hand side).
- Under **Receives** click on **Print Items** menu and select **Move Records to Print Queue**.
- Refresh the screen and keep ILLiad open
- Go to MS Word and Click on the **Merge to New Document**. Make sure everything looks OK and Print the document. **Refresh**.
- Go back to ILLiad and click on **Receives**, then select **Contact Customers** from the drop-down menu.
- Click on **Start Auto Email**. If there are any left in the notification queue, they may need phone or print notification. For phone, double click on the transaction and it will disappear. If print (mail) notification, use the print notification button in the upper right hand corner. (You will need to export to MS Word.)
- Click on the **Refresh** button.

If you have any problems or something doesn't work properly, check out the support pages on the Atlas home page, www.atlas-sys.com. Cheryl Hoover at MSU-Billings is also a good contact; her number is 406-657-1666. Becky Nicholson or Vicki Gist is also available for assistance. Their number is 800-662-6132 ext. 3706.

Receiving *Returnable* Interlibrary Loans

After opening package keep all information together (i.e. boxes, envelopes, loan item, paperwork), until you are ready to process the materials.

- If item was originally an article request, but lending library sent it as a loan, you need to edit the record **BEFORE** you can check it in. Don't forget to **save changes!**
- Click on **Receives** and **Check Items in from Lending Library**.
- Type in the transaction# (if no TN#, you can search by OCLC ILL#, title, etc.) and select **Search**. Verify that all information is correct, both the item and the record.
- Click on the radio button from who sent the item. Double check to see if there are any special instructions (i.e. No renewals, library use only, etc.). If there are special instructions, type those in the notes/special instructions area (such as, return in canvas mailing bag, no jiffy bags, items in back pocket, damaged upon receipt, etc.)
- If there are multiple volumes, change the number of pieces (**Save changes**).
- Check the due date (Make sure the due date doesn't fall on a holiday or day the library is closed).
- Check item in if it's the correct one. Once all materials are checked in, go back to the main menu and click on the **Refresh** button. Will move queue to "Awaiting Post Receipt Processing".
- Click on the **Receives** menu and select **Print Items**. **Move Loans to Print Queue** and hit OK. Click on the **Refresh** button.
- Keeping ILLiad open, go to MS Word. The BorrowLoanSlips.doc should have automatically opened, **Merge to New Document**. If there are multiple volumes, you may want to edit the slips i.e. Vol. 1 of 2). Print document and Exit MSWord without saving. (If no slip came with the item, you may want to print out two copies).
- Cut slips apart and place with materials.
- Go back to ILLiad, click on **Receives** and **Contact Customers**. Click on **Auto E-Mail**. If there are any left in the notification queue, they may need phone or print notification. For phone, double click on the transaction and it will disappear. If print notification, use the print notification button in the upper right hand corner. (They will be exported to MSWord).
- Click **Refresh**. Select **Check Out/In** and **Check Out to Customer**. Enter in the Transaction number from our ILLiad module, not the one on the slip. Exit to the main menu and click **Refresh**.

- Fill out the book strap with the patrons name, phone number, and due date. Check the paperwork that accompanies the material to see if there are any restrictions (i.e. Library Use Only, No Renewals, etc.) Highlight the due date and any restrictions that may be on the book. To attach the book strap to the item, cut a strip of scratch paper so that we do not tape the book. See attached addendum 1a for an example of a book strap.

We also check out the materials in Sirsi so that we can track overdue charges that way.

- ◆ In Sirsi, bring up the patrons record so that the item may be checked out. Set the due date to when you have stated the item should be returned to our library and check out the item using the generic barcode we have assigned to the item. See attached addendum 2a.
- ◆ Click on **Title Maintenance** and then **Maintain Existing Titles**. Toggle the **Current Title** button and click **OK**. Select the **Vol/Copy** tab and insert as much of the title in the **Call Number** Field. See attached addendum 3a.
- ◆ Paper clip ALL of the paperwork together (lending library's and ours) and file it in the correct file, either in the **Due This Month** folder or **Due Next Month** folder.

For additional information about receiving Interlibrary Loans, please check out the Atlas homepage at <http://www.atlas-sys.com/>.

Returning Interlibrary Loans We Borrowed (i.e. Returning Returnables)

- Once we have received the borrowed materials back from the patron, pull the paperwork from the correct folder in the file cabinet. They will either be in the **Due This Month** or **Due Next Month's** folder. Separate our paperwork and the lending libraries paperwork.
- Check In the item in SIRSI to clear the patron's record. Remove the book strap if it is one that we have put on the book. You can put the barcode we assigned the item, back in the filing cabinet. Retain the strap for the transaction # for ILLiad check-in. After the item has been checked-in on the ILLiad side, the book strap can be ripped up or shredded (so info can remain confidential) and thrown away.
- Log into the ILLiad Borrowing module.
- Click on **Check Out/In** and select **Check Items In From Customer**.
- Enter the Transaction Number and click **Search**. Confirm info and select "Check item in". (If no TN#, you can search by ILL#, title, etc.) Continue this process until all items have been checked back in. Return to the main menu and hit **Refresh**.
- Click on **Returns** and select **Print Returns**. Borrowing return labels will automatically open up in MSWord. Click on the **Merge to New Document** and hit OK.
- If the lending library sent us a return label for their materials (usually stapled with the paperwork), there won't be a need to make additional return labels. Go through all the steps, but no need to go to "mailings". Just x-out to main page {**without saving**}, and "refresh". However, if there are multiple labels and there is just one that we have a label for, you can delete that address from the word document and then continue with the usual steps for the other labels. If two or more of the labels are for the same lending library and you are able to package the items together, delete the excess ones.
- Package up materials be sure that the lending libraries paperwork is in the front of the book. Place the proper mailing labels on each package. In the upper right corner put our mail code, "324210" and Library Mail.

If you have any further questions about updating the records, please check out the Atlas homepage at <http://www.atlas-sys.com>.

Renewal Requests

If the Renewal is **Staff Initiated** follow these steps:

- Pull paperwork, double check that the Lending Library allows renewals, than write down the patrons renewal request date.
- In the ILLiad Borrowing module, go to **Edit** then **Edit Request**.
- Search for the request by the transaction # (If no tn# is available, search by ILL#, title, author, etc.)
- Click on **Process** and then select **Renew Request** (It will flash a message if the item is non-renewable).
- **Route** the request to **Awaiting Renewal Request Processing**. Return to the main menu and **Refresh**. The request should be in the **Awaiting Renewal Request Processing** queue.
- Keep paperwork handy, you will need it to do the Renewal Request Process in OCLC directions. Follow the rest of the directions in **Renewal Request Process in OCLC** found on the next page.

If the Renewal is **Patron Initiated** follow these steps:

- You will see a **Renewed by Customer to MM/DD/YYYY** queue in ILLiad.
- Pull the paperwork, double check that the Lending Library allows renewals, than write down the patron's renewal request date.
- Double click on the **Renewed by Customer to MM/DD/YYYY** queue.
- **Route** the request to **Awaiting Renewal Request Processing**. Return to the main menu and **Refresh**. The request should be in the **Awaiting Renewal Request Processing** queue.
- Keep paperwork handy, you will need it to do the Renewal Request Process in OCLC directions. Follow the rest of the directions in the **Renewal Request Process in OCLC** found on the next page.

If the Renewal Request is **granted**, follow these instructions:

- After the Lending Library grants renewal, and we've downloaded from the MicroEnhancer, you will see in ILLiad a new queue **Awaiting Renewal OK Processing**. Double click on this queue.
- In the **Notes** box, you will see **Renewal Due Date: YYYYMMDD** (this is done automatically because of the download).
- Change the due date in the **Due Date** box to match the **Notes Date** if it doesn't already say the same. Remember to **Save Changes**.
- Click on **Email** then **Renewal Granted**. A customer notification e-mail message pops up. Enter **Due Date** into the **Subject** box and click **Send**. (If this is not an option, or isn't the case, just "Change status to" {from drop down menu} "checked out to customer").
- The request will be routed automatically to **Checked Out to Customer** queue. Return to the main menu and **Refresh**.

If the Renewal Request is **Denied** follow these instructions

- To be determined when we actually get one to know which queues open and what steps to follow. To be continued...

*If **staff initiates** the renewal request, it may be easier to go into **Firstsearch**, then **Resource Sharing**, and ask for a renewal by selecting the renewal choice and accessing the date due calendar radio button for the desired due date. Then update the request.

End of Day (Batch Update) Borrowing – MicroEnhancer

This step is only done if you receive, return, or ask for a renewal for an item. To avoid any problems, this step can only be done once a day. Wait until the end of the day after you complete your request processing steps.

- In the borrowing module of ILLiad, select **Process**.
- Click on **OCLC Update Processing** (No one else can be updating and MicroEnhancer **CANNOT** be open at this point.)
- At the top of the screen, click on **Export Borrowing** and hit OK.
- Open MicroEnhancer and select the **Blue B** on the tool bar.
- Click on the **Received** and **Returned** tabs, all OCLC ILL#s that need to be updated should be written in there already. Click OK
- Select the **Upload** button (Green up arrow) on the tool bar and hit OK.
- If there are any problem records, make note (i.e. receives not allowed – you will need to update those separately in Passport when other library updates on its end. You can do a Print Screen for these problems and then update problem records from that.
- Close MicroEnhancer and return to ILLiad.
- Click on the **Clear Borrowing OCLC Files** button. Return to the main menu of ILLiad Borrowing module and **Refresh**.

INTERLIBRARY LOAN (ILL) LENDING ILL

Our lending policies are as follows:

Types of materials loaned:

- Books - 3 weeks use from date of receipt
- Videos - 1-week use from date of receipt
- Photocopies - they keep.

We don't lend:

- Entire issues of magazines
- Reference materials
- Books that are located in our new book display
- Juvenile collection
- Curriculum Materials

Fees:

- We charge reciprocally. In other words, we charge them what they would charge us. We prefer not to charge and are willing to consider reciprocal agreements. We are a member of LVIS.

Types of requests accepted:

- We prefer requests via OCLC, but will accept requests via ALA forms (by mail or FAX).
- E-mail requests must include complete call number/volume as well as a designated library e-mail address.
- Regardless to how we receive the requests, they all need to be entered into our ILLiad system so our statistics will be accurate. Please follow the directions on how to add requests to ILLiad.

Processing ILLiad Lending Requests – Searching Online Catalog

- Log on to the ILLiad Lending module and click on the **Awaiting Lending Request Processing** or **Awaiting Reciprocal Request Processing**.
- Click on the first request (transaction).
- Confirm all address, lender, and shipping information. If all is correct, click “**Select address**” on the bottom of the page. If edits are necessary, make the corrections and click “**Update address**” and then “**Select address**”. If an address needs to be added, confirm all information and click “**Add address**”. Be sure and confirm that “**Exempt**” status is showing and that “**Out of State**”, “**Other Montana Libraries**” or other options are correctly marked. There are pull-down arrows on all of the Borrowing information that you can utilize if you need them. Be sure and **delete** the **Odyssey #** in our Borrower information block (this step may change in the future). Remember to **Save Changes!**
- Click on the **Z Search** button located in the top right of the call number and location information box. You can then search by title, author, ISBN, (ISSN if article), etc., whichever you feel comfortable with and provides the correct information. This will search our card catalog and bring up the location and call number if we own this item.
- Once you find our call number and it is something we are able to loan, you can double click on our record to send the information onto the request page. You can then edit our information. Copy (Control “C”) and Paste (Control “V”) the call number to the Call number box, and the Great Falls-Stacks in the Location box. (We loan videos and books that are **not** in our new book, or reference, juvenile, or curriculum collections.) If it is a loan, and there are multiple items, you can change the number of pieces to match the materials so we can track them all. Remember to **Save Changes**.
- After you have finished, click on the **Finished Searching** tab on the top of the screen.
- If we cannot loan the item (new, in use, citation, exceeds max cost, lack, not owned, etc.) then either send a Conditional OR Cancel the request. Click on the radio button for the reason we are not supplying. When finished, go back to the main menu.
- Click on the **Refresh** button (clock on left hand side). This step refreshes the screen and moves the transactions to the next level for processing.
- Continue through the list of transactions until you have looked through all of them.

Changing Loans to Articles or Articles to Loans – ILLiad Lending

This step is used if the lender wants a certain article or chapter out of a book/journal, and we may want to lend them the entire item rather than copying it; or vice versa, they may have submitted a loan request for a certain article or chapter, but we would rather copy the material and mail it. In this case we would change it from a loan request to an article request. Please follow the steps below:

- This step needs to be done **BEFORE** updating the lending search results.
- Click on **Edit** from the drop down menu at the top of the screen and select **Edit Request**. Enter in the transaction # and hit **Enter**.
- Cut and paste the Article information into the loan area (vice versa for loan to article requests.)
- Remember to change the request type from either article to loan or vice versa. (This is located at the top of the screen and near the middle.) There is a radio button and a drop down menu that BOTH need to be changed.
- Remember to **Save Changes**.
- Change status to **Awaiting Stacks Searching** and click OK. Return to the main menu and hit **Refresh**.
- Select **Search Stacks** from the drop down menu at the top of the screen and click on **Print Stacks Search Items**.
- The document should automatically open into MSWord. Merge to new document and print. Edit any due dates that may need to be changed.
- Print the documents and exit MS Word without saving changes.
- Return to the ILLiad Lending main menu and **Refresh**. Search for the articles/loans and then update them accordingly with the rest of the batch.

Importing ILLiad Lending Requests from OCLC

This is the very first step when dealing with the lending side of Interlibrary Loans. Eventually we will have a connector session that will automatically download the items and import them into our ILLiad client, but for now, please follow the steps below.

- Open the MicroEnhancer and select the **Download Message File Now** (Yellow Down Arrow) icon from the toolbar.
- Click on the lending files (Pending, In Process, and Renewal Request). Make sure both the **Download** and **Print** are checked. And Click OK.

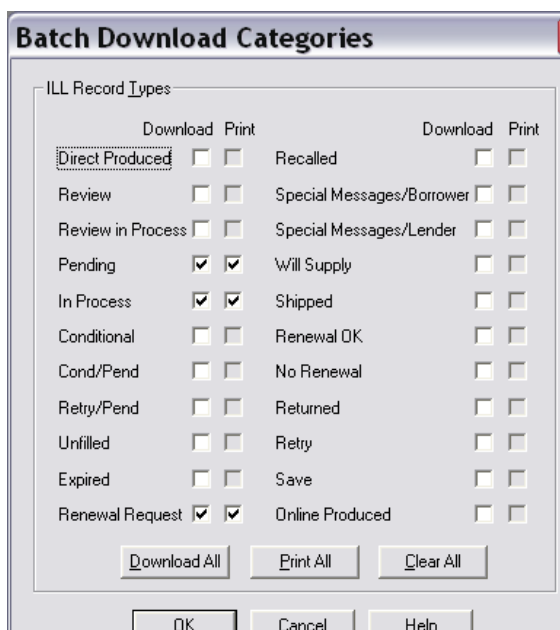

- Click on the **Run Batch Now** radio button. In the **File Name** box make sure it says c:\illiad\lending.in

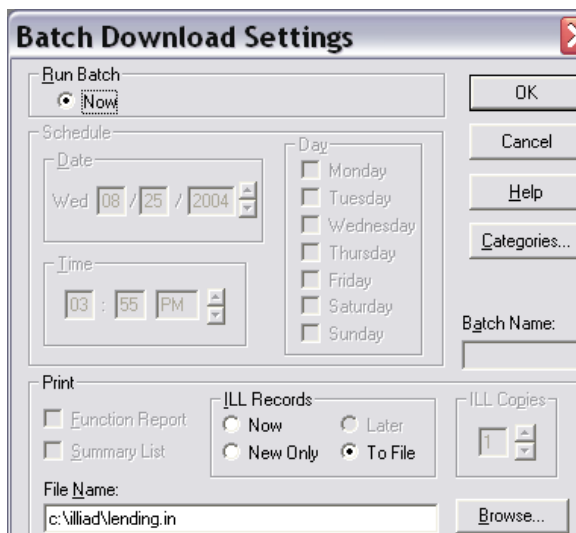

- Click OK. After the download is complete, close the window and exit MicroEnhancer.
- Log into the ILLiad Lending module, and select **Pre-Processing** from the drop down menu. Click on **Import Requests – OCLC** and hit OK.
- The requests will show up in the proper queues after you **Refresh**.

Once you do this step on your computer, the properties should all be default unless you change something. It's still a good idea to double check and make sure everything is going where it should be.

Manual Input of Lending Requests

Regardless of how we receive the ILL requests, they all need to be entered into the ILLiad Lending module. Please follow the steps below:

- Log onto the ILLiad Lending module.
- Make sure the library address is in the database FIRST before adding any requests. You can double check or add their address by clicking on the **Maintenance** drop down menu at the top of the screen and select **Edit Addresses**. Search by either the OCLC symbol or library name. Enter in all information you have available.
- Click on **Request** from the drop down menu at the top of the screen and select **Add Request**.
- Click on the correct radio button stating if it's a loan or article. Change the document type to book or article.
- Select how you received the request (Fax, ARIEL, mail, e-mail, etc.)
- Type in the Call# (copy and paste info from our online catalog)
- Fill in Loan or Article information
- Add the borrowing library's OCLC symbol, making sure that the correct library is highlighted if more than one library uses that symbol.
- Select **Finished Adding Request**
- Write the Transaction # on the original request and click OK
- Return to the lending module main menu and **Refresh**.
- Continue adding requests until all are finished.

After you are finished adding the requests, you treat them as a request that has just been imported into ILLiad from OCLC. Start at step 2 and continue through the process with the rest of the batch.

Printing ILLiad Lending Pullslips – Loans and Articles

After you have completed adding requests manually and changing the statuses of the any requests you are ready to move on to the next step.

- Log onto the ILLiad Lending module.
- Click on the **Search Stacks** drop down menu on the top of the screen.
- Select **Print Stack Search Items** and then **Move Records to Stacks Search Print Queue** and hit Yes.
- This should automatically open MS Word. Click on “**Mailings**”, then “**Finish and Merge**”, then “**Edit & Individual**”, then “**OK**” (Make sure that if you are lending videos to change the pull slip due date to 1 Week Use instead of the standard 3 Weeks Use.) Article and Loan slips will open up into different documents. Make sure you merge both documents if you have a variety of requests to fulfill.
- Delete any records that aren’t being used in order to save toner. Print the documents when everything looks OK.
- Exit MS Word both documents **WITHOUT SAVING CHANGES**.
- Return to the Lending module main menu and **Refresh**.
- Cut slips apart (if multiple) and go search for the materials in the stacks.

Updating ILLiad Lending Stacks Searching Results (Also includes printing address labels and invoices.)

- After locating the materials that the borrowing library is requesting, return to the ILLiad Lending module main menu.
- Click on the **Search Stacks** option from the drop down menu at the top of the screen and select **Update Stacks Search Results**.
- Enter the Transaction # in the top field and press **Enter or “Search”**.
- Click on the desired answer:
 - **Found** means that you are wanting to loan the item
 - **No** means that you either can't find the item or are unable to loan materials. Make sure you give a reason for not loaning.
 - **Conditional** means that you possibly will be able to loan the item, as long as the borrowing library agrees to your stipulations. (i.e. if we were going to charge and they did not state what they were willing to pay.) Make sure you give a reason for the conditional.
- If there is a charge, be sure to enter an amount that we are going to charge.
- When all are done, go back to the main menu and **Refresh**. (Queue then changes to “Awaiting Shipping Label Printing”).
- Go back to the top and select **Search Stacks** from the drop down menu at the top of the screen. Select **Print Shipping Labels** and **Move Items to Shipping Label Print Queue**. Click OK. Return to the main menu and **Refresh**.
- The document should automatically open in MS Word. **Merge to New Document**. Ship items in our canvas mailing bags for **Montana libraries only**. Double check to make sure there is a label already made for a particular Montana library, otherwise go ahead and print/make a permanent label (print out 2 copies of each address so that a marker can be made for which bag is in use). **Do not ship videos in the canvas mailing bags**.
- Print the labels and exit MS Word **WITHOUT saving changes**. Return to the main menu and **Refresh**.
- For those who need invoices sent, click on **Billing and Move Lending Invoices to Print Queue** and click OK. Return to main menu and **Refresh**.
- The documents should again open automatically into MS Word, **Merge to New Document** and Print. Remember to exit **WITHOUT saving any changes**.
- In **Sirsi**, check out the item with **P 100 (ID#)**. Attach one of our return **mailing labels** to the pull slip for items that are **not** mailed in our mailing bags. Package item, write our **mail code**, 324210, in the upper right hand corner, and ship.

Checking Loaned Items Back In and Answering Renewal Requests

When our item is returned from a borrowing library find the paperwork in the front cover of the material being returned.

To Update in ILLiad:

- Log on to ILLiad Lending Module
- Click on the Receives drop down menu and Select “Check Items in from Returning Library”
- Enter the transaction number that is located at the top of the pull slip.
- Make sure all information is correct and click on Check Item In.

Check In Items on SIRSI:

- In the circulation toolbar,
- Click “Discharge/Checkin”
- Scan the barcode
- The window says route to STACKS, VIDEO, or PERIODICAL
- Click “Close”
- Make sure the item is sensitized and then it is ready for reshelving.

Answering Renewal Requests

- Log on to the ILLiad Lending Module and double click on **Awaiting Renewal Request Processing.**
- Double click on the transaction # to bring up the request.
- Select **Process** from the dropdown menu at the top of the screen and choose **Renewal.**
- You can respond either
 - **Yes to renewal request** – This allows you to select your own due date. One important thing you need to remember is that you **NEED** to insert the new due date **BEFORE** you respond yes to renewal request.
 - **Yes with a Due Date of xx/xx/xx** - This automatically selects the due date, which is set for 3 weeks from the original due date, not the day the renew was requested.
 - **No to renewal request** – This denies the request and the borrowing library should return our materials by the original due date.
- Once you have selected your option, the record will automatically get updated.

Updating ILLiad Lending External Systems

Once all of the ILL requests have been processed we need to update the statuses in OCLC. Please follow the steps below.

- Log onto the ILLiad Lending module and select **Process** from the dropdown menu at the top of the screen.
- Select on **OCLC Update Processing** and select **Export Lending**. Click OK.
- Minimize this window, be sure not to close it because you will be needing it again in a few minutes.
- Open Passport, start a new session in the **Interlibrary Loan** module.
- After it logs onto our OCLC account and the cursor is in home position (upper left hand corner) hit **Control + U** (Ctrl+U)
- This will automatically start updating any records that were processed through OCLC. Once it is finished going through everything, disconnect from your session in Passport and return to ILLiad.
- Click on **Import Results**, make sure everything came through without any errors. If everything comes across as being OK go ahead and clear the results. If errors come across, take note of the ILL numbers and investigate (Usually happens when we check items back in without the borrowing library updating the status to show it was returned.)
- Return to the main menu and **Refresh**.

This is the final step after all requests are processed for the day. Once the connector is in place, the records will automatically update at 2:00 PM daily. Once this takes place, please make sure all article requests are processed by this time to ensure we get our lending credits.

A few additional Passport Keystrokes that might come in handy:

- **F3** = Exit
- **F4** = Page Down
- **F5** = Page Up
- **F6** = Message File
- **F11 or 10-key Enter** = Enter

For further assistance check out the atlas homepage at www.atlas-sys.com or contact MSU-Billings or MSU-Northern libraries for assistance.

Sending and Receiving Ariel

Please see a copy of the Ariel User's Guide to help you send and receive documents. I have attached a copy of the cover page that is sent at the beginning of every request sent. Please watch your print jobs carefully so that none of the Interlibrary Loans get lost in the shuffle. A coversheet which is included in this section will separate each of the ariel documents. Once you receive a request on the Ariel, finish processing the item in ILLiad as if it were mailed or faxed.

The computer that the Ariel program is loaded on needs to be on at all times.

Our IP Address is 207.196.130.82

Please follow the user's guide (located in this section) to help you send and receive ariel documents.

INTERLIBRARY LOAN (ILL) OVERDUE ILL

Borrowing Libraries:

Every Wednesday when we process overdues for our patrons, we also run the overdue reports for Interlibrary Loans in ILLiad. Please follow these steps to process overdues.

- Log onto the ILLiad Lending module
- Select the **Process** dropdown menu from the top of the screen and choose **Overdues**. If any items are overdue, they will automatically pop up in either the first, second, or third notice section.
- Click on the **Print/Send Overdue Notices**. You will have to go into the ILLiad I: Drive and open up the appropriate letters we would like to send.
 - My computer
 - **YQYILLiad I: drive**
 - Select the **Print** file
 - Choose the appropriate letter, either LendingOverdueLetter 1, 2, or 3. Open the file and **Merge to New Document**.
 - If you have an email address for the library, just copy and paste the letter into an email otherwise print a copy and mail it to them.

Interlibrary Loan ILLiad Reports

To get to the ILLiad Reports website go to
<http://illiad.msubillings.edu/illiad/webreports/default.html>.

When running the end of the year reports for our borrowing information, click on ***Borrowing Reports*** from the list of reports. We run reports for the ***Most Requested Journals*** and ***Most Requested Loans*** from this list. The instructions are the same for both reports. After the reports are ran, print copies and give to the head librarian.

- Set the date range from July 1 of the previous year through June 30, of the current year.
- Set the number of requests to *zero*.
- For the Site information unclick “*All*” and select “*YQY*” instead.
- For the Group information leave “*All*” selected. If you unclick all and select different groups from the YQY group options, the stats will be wrong. Haven’t figured out why this is, but this seems to work.
- Click on ***Generate Report***

For the lending reports, the most important one is the Montana Library Interlibrary Loan Reimbursement Program information. This reimbursement is for loans that we have filled to other Montana libraries (excluding MSU-Bozeman, MSU-Billings, and MSU-Northern). Click on ***Lending Reports*** from the list of reports. We want the information generated from the ***Who We Loan To*** report. Look for paperwork that will be mailed to the head librarian around the end of May each year. This needs to be completed and returned to the Montana State Library by the date given.

- Set the date range from July 1 of the previous year through June 30, of the current year.
- Set the number of requests to *zero*.
- Set the request type for *both*.
- For the Site information unclick “*All*” and select “*YQY*” instead.
- For the Group information unclick “*All*” and select “*(YQY)Other Montana Libraries*” instead.
- Click on ***Generate Report***

WEAVER LIBRARY PROCEDURE MANUAL

Overdues

- Scheduling of Billing Reports

 - Overdues (Weekly)

 - Fines (Monthly)

 - Lost Items (End of Semester)

- Running Report

- Checking the Shelves

- Final Overdue Notices

- Bills

 - Weekly

 - Student Overdue Letter for \$25+

 - Monthly

 - End of Semester

- Sample Letters

OVERDUES: SCHEDULE OF BILLING REPORTS (overdues, fines, lost items):

1) **Weekly** (Wednesdays) - Overdue Reports

a. In addition to the notice being sent to the patron, a courtesy phone call or email is done to remind the patron of their overdue.

b. *Any lost item (30+ days overdue) letters should be sent to 1) to the patron, 2) to Business Office (prior to sending to the Business Office, letter should be given to Kirsten), 3) retained in Library records. Notation made on patron's file and also the record for the item lost.

**Interlibrary loan overdue -- make notation in patron's record. ILL privileges will be revoked until paid.

2) **End of Month** - Unpaid Fine Reports (item no longer overdue, but fines unpaid)

a. At the end of every month we send out bills to patrons. This report is run, by selecting the "GF Monthly Bill Template" and setting the date range for the previous two months. (i.e. If you were running the bill the end of November, you would set the date range between October 1st and November 30th.) This allows patrons to receive their first and final bills relatively close together.

b. For Final notices and fines in excess of \$25, send a letter to 1) the patron; 2) Business Office (give to Kirsten prior to sending to the Business Office; 3) retained in Library records. Create a notation in the patron's file indicating that the bill went to the Business Office.

c. We no longer run bills at the end of the semester and then again at the end of the month, running them at the end of each month is more efficient.

d. Copies of final bills will still be retained in the Library's records.

*** Note for lost items or overdue fines \$25 and over – The patron privileges are revoked until fines paid.**

****ILL patrons and courtesy borrowers may lose library privileges if fines remain unpaid or a pattern of overdues/fines is established.**

*****Patrons who have not paid their fines by their final billing notice will have their library privileges suspended until the bill is paid for. They may pay either here or at the business office.**

******Any items turned in to the Business Office needs to be added to the "Sent to BusinessOffice.xlsx" spreadsheet (located in the "Monthly" folder on the common drive).**

RUNNING REPORT: Weekly Overdues

Currently, overdue reports are run every Wednesday. We are currently sending out first, second, and final overdue notices.

Open the reports toolbar in Sirsi
Click "Schedule new Reports"
In the Templates tab, highlight "GF Weekly Overdue Notices"
Click "Setup & Schedule"
Click "Schedule"
Click "OK"
Click "Close"

Now you have to wait a few minutes for the report to run...

Click "Finished Report"
Highlight the report that says, "GF Weekly Overdue Notices" that was run on the current date
Click "View"
Click "OK"

Delete everything that comes before the overdue notices
Select all of the text (Ctrl+a) and change the font to 9.
Adjust the letters to one per page, with the date of each letter at the top of the page.
Print the overdues.
Close document without saving changes.
Follow directions for OVERDUES: CHECKING THE SHELVES.
Follow directions for OVERDUES: BILLS

With "Finished Reports List" still open highlight "GF Weekly Overdue Notices" for the previous week.
Scroll through the report for any final notices.
Check in SIRSI to see if item(s) was returned.
Print any final notice that has not been returned and give to head librarian for replacement costs.
Follow instructions for OVERDUES: FINAL OVERDUE NOTICES.

RUNNING REPORT: End of Month fines

The Monthly Bill is run on the first working day of the Month.

Open the reports toolbar in Sirsi

Click "Schedule new Reports"

In the Templates tab, highlight "GF Monthly Bill Template"

Click "Setup & Schedule"

Click "Selection Criteria" tab

Change "Date Billed:" criteria to the previous **two** months (i.e. on Oct. 1st set criteria as Aug 1st to Sept 30th)

Click "Schedule"

Click "OK"

Click "Close"

Now you have to wait a few minutes for the report to run...

Click "Finished Report"

Highlight the report that says, "GF Monthly Bill Template"

Click "View"

Click "OK"

Delete everything that comes before the notices

Select all of the text (Ctrl+a) and change the font to 9.

Adjust the letters to one per page, with the date of each letter at the top of the page.

Print 2 copies of each Final Bill notice. Give one copy to Kirsten and mail the other copy to the patron.

Save the document with password protection* in the "Monthly Bill" folder on the Library common drive.

Close document.

*To password protect document:

Click the "Office Button"

Click "Save As"

In the "Save As" dialog box, click "Tools"

Click "General Options"

Type the password in the "Password to open" and "Password to modify" text boxes

Change the location to the current fiscal year's folder in the "Monthly Bill" folder on the common drive

Name the file with the previous month's date (i.e. if report is run on Nov. 1, 2008, name the file as 10-2008.docx)

Click "Save"

OVERDUES: CHECKING THE SHELVES

Work-study students can check the shelves for the overdue items.

Use the printed reports to check the shelves for those items. Overdue Library items are sometimes found on the shelves. Sometimes a patron will place the Library item on the shelves after receiving a notice and occasionally the book wasn't checked in properly by the Library Staff. The Library item would have been found previously when the shelves were checked before sending out notices.

If you find an item on the shelf, check the barcode on the notice with the barcode on the item. Sometimes, we have two copies of an item and it looks like the item has been returned, but actually the second copy is checked out.

If an overdue item is found on the shelf, bring it to the Library Technician to correct. If the two barcodes match put the overdue notice with the item, and correct the error. Follow the procedure below to correct overdue errors.

CORRECTING RECORDS FOR OVERDUE ITEMS FOUND ON SHELF

Take the "overdue" item you found on the shelf to the main desk and check it in. A fines window will appear.

If the overdue notice is the first overdue, you can forgive the entire fine.

If the overdue notice is the second or final overdue, you subtract seven days off the fine (allowing for weekly overdue reports). Subtract seven days from the amount of the fine because we don't know when it was returned.

After taking care of fines, shred the overdue notice.

Keep patron's information confidential.

OVERDUES: FINAL OVERDUE NOTICES

Final overdues are more serious. Books that have not been returned in 30 days or more are declared “LOST”. The patron is assessed a cost of replacement plus a \$20 processing fee for each item that is not returned.

The patron can either 1) return the Library item and pay the overdue fine or 2) pay the replacement cost plus processing fee. Library privileges are revoked until the patron has settled the Library bill. The patron's record is **BLOCKED**.

Currently we have been sending out the lost form letter two weeks after the final overdue is sent. Keep the final overdue report so that you can refer back to it as necessary. If any patron was sent a Final Overdue, double check their records to see if the item is still overdue.

To find the replacement cost, give the head librarian the final overdue notice to look up the item so that we can get an accurate amount that it will take to replace the item. Some of the items are harder to replace than others and the prices in the SIRSI record are not always accurate.

Use the Lost form letter (LostItem letter.docx) in the “Overdue & Lost item letters” folder found in the “Forms – items to print” folder on the common drive to send to the patron. Print 3 copies of the Lost Item Letter; 1 for the patron, 1 for the library’s records, and 1 for the Business Office (give to Kirsten prior to sending to Business Office). Save the letter with password protection* in the “Patron Letters” folder on the common drive (found in “Overdue & Lost item letters” folder in the “Forms – items to print” folder). Follow the steps below to update the patron and item records.

Adjust the patron’s record in SIRSI:

- Click on “Billing a User”. Enter the patron’s ID number and press Enter on the keyboard. Choose “Lost” as the Reason for bill in the drop down list. Enter the amount owed (replacement cost + \$20 processing fee) and the item’s barcode number. Click “Bill User”.
- Make a notation in the patron file indicating sent to the Business Office, replacement cost plus the \$20.00 processing fee (ex. A book that costs \$19.95 and a processing fee of \$20 would be entered as “\$39.95), date, and initial.
- You cannot change the status of a checked out book to being lost, so you have to check the item in and then change the record. (This will automatically move the overdue fine into a bill.)

(Leave the overdue bill amount in the Patron's record. If the Patron returns the Library item, charge the Patron the overdue bill amount only. If the item is not returned, the Patron owes the amount of the replacement cost of the item plus a \$20 processing fee.)

Adjust the location of the item to LOST in “Call Number and Item Maintenance”. Also under the Circ Notes section of the record, note who lost the book (Patrons name and ID number.) followed by the date and your initials. **MAKE SURE TO ONLY ENTER THIS**

INFORMATION IN THE CIRC NOTES CATEGORY SO THAT THE PATRON INFORMATION IS NOT TRANSFERRED TO ILINK.

Patrons can make payment at either the Business Office or in the Library. If payment is made in the Business Office, they will notify the Library via email so the patron's file can be updated. If payment is made in the Library, notify the Business Office via email so they can update their records.

What about serials?

Look in the file cabinet for the latest EBSCO serial renewal list to find the subscription price. If it's not there, look through the first few pages of the serial to see if you can find the subscription cost. Divide that cost by 4 for quarterly serials; divide by 12 for monthly serials, etc. to get the cost to replace a single issue.

Now that you have the cost of the item, add \$20.00 to it. We charge a \$20.00 processing fee for all lost items.

*To password protect a document:

Click the "Office Button"

Click "Save As"

In the "Save As" dialog box, click "Tools"

Click "General Options"

Type the password in the "Password to open" and "Password to modify" text boxes

Change the save location

Name the file

Click "Save"

OVERDUES: BILLS

Weekly Overdues

After you create the weekly report and open the report in Word, (**Refer to *Running the Overdue Report***) highlight all of the text and change the font size to 9. Adjust the letters so there is one patron per page. Print the letters.

Sort through the bills you printed. Separate letters between faculty/staff, courtesy, and students. Check the shelves for the overdue items. (**Refer to *Checking the Shelves***)

Faculty/staff overdues can go directly to their box in the mailroom. Faculty/staff are not assessed fines but will be charged for lost items. If a faculty/staff member loses an item, they will be assessed the replacement cost of the book plus a \$20 processing fee. Any action taken or records maintained will be handled only through the Library. Bozeman and Northern Faculty and staff are assessed fines because of their “home” libraries. We can go ahead and clear the fines that are from our library. Northern has a box in the mail room that you can put all notices in. For Bozeman faculty, I have been copying the notice into an email and sending it to the individual patron since they have been relocated off campus this is much easier. You can find the email addresses in the address book.

Courtesy borrower overdues will be mailed to the patron. In addition to the notification, patrons should receive a phone call/e-mail on the First Overdue Notification. If appropriate, list their record as "BLOCKED" with a notation of the action including date and initials. Library privileges for courtesy patrons can be blocked at the discretion of the Librarian.

Students should be mailed an overdue notification. In addition to the notification, students should receive a phone call or e-mail on the First Overdue Notification. A work study can mail the overdues using a windowed envelope with a penciled notation of 324210 in the upper right hand corner of the envelope where the stamp would be located.

Any Overdue item that has not been returned in thirty (30) days (Final Notice) is declared **LOST**. (**Refer to the *Final Overdues section***.) Use the Lost Library item form letter (LostItem letter.docx) in the “Overdue & Lost item letters” folder in the “Forms – items to print” folder on the common drive. After filling out the information, save the letter named as the patron’s last name in the “Patron letters” folder. All lost items that were billed on SIRSI will be sent to the Business Office. If the patron returns a LOST book, the Library will charge the patron the amount of overdue fees only. Notify the Business Office that the library item was returned and if appropriate, that the overdue fee was paid. If the overdue fee was not paid, inform the business office of the correct amount now due (just the amount for overdue fees still owed). Correct the item in SIRSI

under the patron's record and change the status of the Library item in Cataloging Title Maintenance.

Monthly Bills

Once a month, the library runs a monthly bill report. Final notices (or bills that total more than \$25.00) are sent to the Business Office. Make sure that the items have not been previously sent to the Business Office.

Save the bills in the common drive using the password protection feature. Name the file according to the Month/Semester and select the Option area to password protect the file. The password we use is "holdings".

After any bills are sent to the Business Office, update the "Sent to Business Office" spreadsheet located in the "Monthly Bills" folder.

MSU-Great Falls Campus Library
2100 16th Ave. South
Great Falls, MT 59405-4909

TODAY'S DATE

PATRON'S NAME / ADDRESS

Dear PATRON'S NAME

On **DATE OF ILL ITEM**, we obtained **TITLE OF ITEM** for you through interlibrary loan. Its due date was **DATE ITEM WAS DUE**.

Because this item still hasn't been returned, you are being notified that your library privileges will be suspended until this item is returned and any overdue fines from our library as well as any fines accrued from the lending library are paid. Fines unpaid at the end of the semester are sent to the Business Office for collection. The Business Office will add the amount due to your student account and may withhold academic transcripts and other university services from you until the amount is paid in full.

Please call 771-4398 if you have any questions. Thank you for your prompt attention to this matter.

Sincerely,

LIBRARIAN'S NAME

Librarian

MSU-Great Falls Campus Library
2100 16th Ave. South
Great Falls, MT 59405-4909

TODAY'S DATE

PATRON'S ADDRESS

Dear **PATRON'S NAME**

On **DATE ITEM WAS CHECKED OUT**, you checked out **TITLE OF ITEM(S)** from our library. The due date was **DATE ITEM WAS DUE**.

Since materials more than thirty (30) days overdue are considered lost, your bill has been sent to the Business Office for collection. Bills include the cost of replacing the lost item and a \$20 per item processing fee. The Business Office will add the amount due to your student account and may withhold academic transcripts and other university services from you until the amount is paid in full. Your library privileges are also suspended.

Item	\$ [REPLACEMENT COST]
Processing Fee (\$20 * X)	\$ <u>00.00</u>
Total	\$ [REPLACEMENT COST + \$20]

Please call 771-4398 if you have any questions. Thank you for your prompt attention to this matter.

Sincerely,

LIBRARIAN'S NAME

Librarian

Using Banner

Username – your username
Password – your password
Database – Enter in MSTR

****NEVER USE ROLL BACK****

To check for Current Student:

SFAREGS Current Term (ex. 200270)
 Enter Banner number WITH the – (ex. -00010000)
 Control Page Down
 AD-Administration Drop
 WS-Withdrawn

To check Balances: (Easiest and quickest)

TSAAREV After entering into the database
 Select Black X (upper right corner) to get past printer destination.
 Enter Banner number WITH the –
 Control Page Down –
 If there is a hold – the password is ovr
 Select Enter Query (middle of toolbar with red question mark)
 Enter LIBF in the detail code to bring up only library fines
 Press F8 to start query

To check Address/Phone Number:

SPAIDEN Enter Banner Number WITH the –
 Control Page Down (3 times)

To Query for Fines: (Takes forever – brings up any fine not just current)

TGIACCD Select Black X (Upper right corner) to get past printer destination
 LIBF in the Detail code
 Press F8 to start query

To look up Name without Banner Number:

SOAIDEN Enter last name

To Change Passwords:

GUAPSWD – Enter old password with your new password

WEAVER LIBRARY PROCEDURE MANUAL

Tasks

Master List

Detailed Lists

Yearly

Semester

Monthly

Weekly

Daily

As Needed

Daily Tasks

Gate Count

Annual Tasks

Interlibrary Loan Reimbursement

As Needed

Adding Barcodes to Serials

Hourly Count

Making Computer Help Desk Requests

Moving WorkFlows Settings to a New PC

TASKS

This section is arranged by frequency and timing of the task. Detailed instructions and outlines of tasks are located in the relevant section, i.e. instructions for weeding serials are under Serials, instructions for Annual Inventory are under Reports. A list detailing where the instructions for each task can be found are at the end of the section.

The notes for each task indicate when the task is to be done, and who is responsible for doing it. These notes are intended as an outline only and the instructions for the task should be fully reviewed to determine more about the setup, timing, and staff involved.

TASKS: Master List

Yearly

ILL summary
Inventory/Collection value (end of June)
Ebsco subscription renewal
Periodical Maintenance (Jan &/or Jun.)
Courtesy Borrower purge (May/Jun)
User profile reports (i.e. users not matching profile)
Stats Reports
Surveys (Faculty and Students)
Send list of subscriptions (or as needed) to Serials Solutions
Update union listings and OCLC (Dec/Jan)
Review govt/online publications in iLink
Old patron record purge (1 year old)

Every Semester

Reserve Update
Shelf Reading rotation completed
Next semester open/closed dates to BZ
Create signs and bookmarks for regular and special hours
Update list of programs provided in computer lab
Catalog purge of “required field” items
Change voicemail message
Create temporary phone message
Check for lost/missing items on shelves
Workstudy scheduling
Workstudy evaluations
Change automatic shutdown (if necessary)
Check/add regularly occurring tasks on calendar

Monthly

Ebsco Claims: Duplicates/Missing Copy Bank
Collection Development reports (Items removed)
Weeding newspapers
Fine reports
Outstanding fines to Business Office
Bill Notices
Gate statistics
Check Credo database
Clean security gate filter

Weekly

Overdue Reports (Wed.)
Drawer Reconciliation/Deposit (Thurs or Fri)
Shelf read

Daily

Gate Count (opening and closing)
Process serials
Check and process ILLs
Sort Outlook file
Sort mail and distribute

As Needed

Lost Book / \$25+ fines report to Business Office
Repair books
Computer issues Log

Cleaning

Clean shelves
Clean keyboards/mice with sanitizer
Clean computer screens and desk areas
Clean carrels and tables
Check lights

Yearly Cleaning (Maintenance)

Window Cleaning
Carpet cleaning

DAILY TASKS: Gate Count

A daily log is kept of the gate count.

Check the display towards the bottom of the gate closest to the new book section. There is a digital readout of how many people have gone through the gate, and how many times the alarm has gone off. They alternate between the two numbers, so make sure you are recording the correct one.

You can see this as:

For the patrons, the number will look similar to P557136

For the alarms, the number will look similar to A2691

In this example, 557136 people have passed through the gate, and the alarm has gone off 2691 times. Of course, the actual amount of people should be divided in half because the gate is counting patrons entering and leaving the library for a given day.

Write down the “P” number in the morning before the doors are opened, and at night after the doors are closed.

The insignificant amount created by Library staff, and work-study students (both library and computer lab) using the gate do not affect the stats that greatly. Remember that stats have a + or - factor.

If the gate malfunctions, clean the filter on the side of the gate near the New Books section. Any gate amounts during the malfunction will be lost.

ANNUAL TASKS: Interlibrary Loan Reimbursement (7/1)

ILL reimbursement is done at the end of every June. Look for the mail packet around the end of May or early June. The packet is due back to the Montana State Library on or before July 10, *no exceptions!*

The packet is pretty straightforward with the directions.

Our Library's Federal Tax ID Number is 81-0522790.

To find the libraries loaned to and the number of items loaned, get some scrap paper, the Montana Library Directory, and the folders in the ILL drawer labeled: "ILL we lent," and "ILL MSU-COT Materials on loan."

Go through each request in each folder dated between 7/1 and 6/30. Write the name of the libraries on the scratch paper and use hash marks to indicate each request. When you've written them all down, look them up in the Montana Library Directory. If they're not listed in the packet, cross them off the list.

Now you can transfer the remaining ones to the packet. You may need to photocopy the sheet this information goes on. Use the typewriter to fill in the worksheets.

Apply the appropriate signatures and dates and mail it to:

ATTN: Interlibrary Loan Reimbursement
Montana State Library
1515 East 6th Avenue
Helena, MT 59620-1800

AS NEEDED: Adding Barcodes to Serials

Serials are not barcoded until checkout because it is not cost effective to barcode all serials. When a patron checks out a serial that isn't barcoded, we have to enter the info into Sirsi.

Apply a barcode and date due sticker to the serial, taking care to avoid the serials date or volume/issue information. The barcode should be placed (vertically) directly below the yellow dot, in the upper left corner. The date due sticker should be placed in the lower right corner (if this obstructs information, it may be placed on the back cover).

In the circulation toolbar...

Click "Title Maintenance" then "Maintain Existing Titles"

Search using "Periodical Title" and enter the name of the journal

Change the library to GREATFALLS

Click "OK"

Open the appropriate item. Highlight the auto barcode and scan the new barcode into the item ID field.

Click OK

Now that the serial is in Sirsi, you can check it out to the patron.

Click "Checkout"

Scan the patron's ID, delete the dash and add an "8" to the front of the Banner number.

Click "OK"

Scan the barcode on the serial

Click "OK"

Fill in the Date Due sticker and tell the patron when the item is due

Click "Close"

ANNUAL TASKS: Weeding Serials

Our library is small and instructors want students to have the latest information, so we weed the serials at the beginning of every calendar year.

Generally, anything older than five years is removed from the collection. Put up a “give away” table in the Atrium to put unwanted serials and send an “Everyone” e-mail to notify the campus that this is available.

Staff will weed out the old journals from the shelves. Do not remove any journal that combines issues at the end of the year (last issue in December and first issue in January even if the issue is dated older than 5 years). Issues then need to be removed from SIRSI.

Student workers (or full-time employees) can then remove any property markings, stamp as discard, and desensitize from the deleted issues.

Cleaning

Task	Responsibility	Backup
Clean shelves	Student Worker	staff
Clean keyboards/mice with sanitizer	Student Worker	staff
Clean computer screens and desk areas	Student Worker	staff
Clean carrels and tables	Student Worker	staff
Check lights		
Clean Windows	Maintenance	
Clean Carpet	Maintenance	

ANNUAL TASKS: Inventory

Toward the end of every June, we have to do an inventory of the library’s books, videos, AV items, and periodicals. The inventory is an estimate of the monetary value of the collection; it isn’t precise.

Look at previous inventory reports to help you do this. They are in the file cabinet in Sheila’s room under “Inventory” folder.

Here is a sample table for the inventory report. You need to fill in the blanks. An “Inventory Blank” file can be found under “Inventory” in the Annual Reports folder.

Total number of books in the collection: _____	
Total number of videos in the collection: _____	
Total number of AV items in the collection: _____	
Total number of items in the collection: _____	
_____ periodical subscriptions (includes _____ newspapers) with average back file of 5 years. Yearly subscription cost \$ _____	\$ _____
BOOKS, VIDEOS, AND AV ITEMS WITH PRICE	
_____ books with price. Average price \$ _____ /volume	\$ _____
_____ videos with price. Average price \$ _____ /volume	\$ _____
_____ AV items with price. Average price \$ _____ /volume	\$ _____
BOOKS, VIDEOS, AND AV ITEMS W/O PRICE	
_____ books w/o price. Average price \$ _____ /volume	\$ _____
_____ videos w/o price. Average price \$ _____ /volume	\$ _____
_____ AV items w/o price. Average price \$ _____ /volume	\$ _____
ESTIMATE OF TOTAL VALUE OF PERIODICALS, BOOKS, VIDEOS, AND AV ITEMS	\$ _____

Stop processing a week before the end of the month. This allows us to have the needed report before the larger libraries run the automatic yearly reports. The other advantage is that it allows the Financial Department time to make the necessary yearly adjustments. This policy coincides with the other departments at MSU-GF.

Reports run to get inventory results include: Count Items and Average price of Books. Each of these must be run three times, one for each item type category. Reserve items are not counted because, for the most part, they don’t ‘belong’ to the library. The three item type categories are: books, videos, and AV (includes AV, CDs, Slides, Cassettes, Films, and Kits).

To count the number of books, open Sirsi to the reports toolbar.

- 1) Click “Schedule New Reports”
- 2) Click the Bibliographic” tab
- 3) Click “Count Items”
- 4) Click “Schedule”
- 5) Click the “Selection Criteria” tab

Use the diamonds!

- 6) Library: GREATFALLS

- 7) Home location: STACKS, REFERENCE, VIDEO (there are books among the videos, and remember, **don't** count reserve!)
- 8) Item type: BOOK
- 9) Click "Schedule"
- 10) Click "OK"
- 11) Click "Close"

The report takes 30-60 minutes to run. Meanwhile, you can run the other Count Item reports.

To count the number of videos, follow steps 1-6 outlined above. The Home location is VIDEO. The Item type is VIDEO. Steps 9-11 are the same.

To count the number of AV items, follow steps 1-6 outlined above. The Home location is VIDEO. The Item type is AV, CASSETTE, CD-AUDIO, CD-ROM, FILM, KITS, SLIDE. Steps 9-11 are the same.

To figure the average price of books, open Sirsi to the reports toolbar.

- 1) Click "Schedule New Reports"
- 2) Click the "Bibliographic" tab
- 3) Click "Average price of books"
- 4) Click "Schedule"
- 5) Click the "Selection Criteria" tab
- 6) Scroll down to the Copy Selection part of the page

Use the diamonds!

- 7) Library: GREATFALLS
- 8) Home location: STACKS, REFERENCE, VIDEO (there are books among the videos, and remember, don't count reserve!)
- 9) Item type: BOOK
- 10) Price: >0
- 11) Click "Schedule"
- 12) Click "OK"
- 13) Click "Close"

The report takes 30-60 minutes to run. Meanwhile, you can run the other Average Price reports. When Average Price reports come up, they have about 38 pages of error messages. I don't know why, or what they mean. I've been deleting the error portion, and condensing the report to one page before printing.

To figure the average price of videos, follow steps 1-7 outlined above. The Home location is VIDEO. The Item type is VIDEO. Steps 10-13 are the same.

To figure the average price of AV items, follow steps 1-7 outlined above. The Home location is VIDEO. The Item type is AV, CASSETTE, CD-AUDIO, CD-ROM, FILM, KITS, SLIDE. Steps 10-13 are the same.

Print the reports after they finish running. Remember to condense the Average Price reports to one page!

Now, for the actual inventory report...

Get the most current Serial Holdings list. Count the number of entries on the list. Count the number of newspapers we subscribe to. Add the newspapers to the serials for the total number of periodicals. To find the yearly subscription cost, get the most recent EBSCO invoices, and look at the last page. There are separate EBSCO invoices for regular serials and MSU Nursing serials. These costs are multiplied by 5 because most subscriptions are kept for 5 years.

You can fill in the BOOKS, VIDEOS, and AV ITEMS WITH PRICE sections fairly easily using the information in the completed Average Price Reports. Use these same reports to help you fill in the BOOKS, VIDEOS, and AV ITEMS W/O PRICE sections too.

Example: You know the library has a total of 5554 books
 You know 1301 books have a price
 You know the average price of those is \$19.66/volume
 Subtract 1301 from 5554 to find the number of books without a
 price ($5554-1301=4253$)
 Assume the same average price for the books that don't have a
 price (\$19.66)
 Multiply the average price with the remaining books
 ($\$19.66*4253=\$86,613.98$)

Do the same for the VIDEOS and the AV ITEMS.

When you have all the subtotals, add them up for the grand total

Save the completed inventory table in the common drive. The other inventory reports are in the "Annual Reports" folder, then in the "Inventories" folder. I've been calling them "Inventory FY 00-01" (meaning Fiscal Year 2000-2001).

Print off the completed inventory table. Put this with "supporting evidence" into a packet. The packet should include: The inventory table

- The three item count reports
- The two EBSCO invoices (photocopied)
- The three average price reports

File this in the "Inventory" folder in our file cabinet.

A copy of the completed inventory table needs to be turned in to the Controller in the Business Office.

Revised/sb: 7-10-02

AS NEEDED: WORKFLOWS SETTINGS

How can we keep existing WorkFlows settings when moving to a new PC (i.e. workstation)?

Many of the WorkFlows settings are determined by the properties file used by the login. When a user logs onto a new PC using the same login as previously, any settings that were saved to the server will be downloaded to the new PC. However, if you want to retain the settings the user had saved to his/her PC, you will need to copy some files from that user's PC to the new PC.

From the user's existing PC backup the following files:
C:\Program Files\Sirsi\Workflows\property.dat and C:\Program Files\Sirsi\Workflows\ToolCust* (whatever files are in that directory). Since each user might have a different WorkFlows setup, each fileset on each PC will need to be backed up. On the new PC, download the WorkFlows client as usual. Test it to be sure it operates normally. After you are sure it is working, then reload the backed up files overwriting the files if they exist on the new PC. Close WorkFlows, and reopen it. It should display the settings you had previously saved.

--From the Sirsi Website, courtesy of Doralynn Rossman, 5/3/04.

WEAVER LIBRARY PROCEDURE MANUAL

Patrons & Policies

Valid IDs for Checking Out Materials

Computer Lab Access

Courtesy Borrower

Patron Borrower Policies

Undergraduate

Faculty & Staff

Graduate Students

Distance Students

Affiliate Faculty

Community

Library Policies

Children in the Library

Conduct Policy

Group Study Rooms

Interlibrary Loan Service

Reserve Material

Library Wireless Checkout

Library Laptop Checkout Agreement

PATRONS: Valid IDs for Checking Out Materials

Alter Banner Numbers for check-out

When an item is checked out to a GFC MSU Fac/Staff/Students, delete the dash and enter an “8” at the beginning of the Banner number.

Northern or Bozeman Fac/Staff/Students need to have a “9” entered in front of their Banner number.

Students

All students are required to use a student ID to check out materials. Banner uploads (weekly) will assure that the database has current students only.

Student IDs are created at Student Central. If a student did not have an ID card, refer them to Student Central to have a card created.

Any updates for SIRSI information (phone number, address, etc.) must be made through Admissions only. We do have change of address forms in the upper right drawer of the front circulation desk. If a student fills them out they need to return it to Student Central or we can turn it in for them.

Great Falls College MSU Faculty/Staff Members

Regular Faculty/staff members tend to not bring their employee ID with them. This has been OK. They usually identify themselves to the work-study by saying they are faculty/staff and give their name.

Adjunct faculty members are required to have Great Falls College MSU employee IDs when they need to check out materials. If they do not have a faculty/staff member ID, they need to go to the Assistant Registrar to obtain a card before they can check out materials.

Bozeman/Northern Students and Faculty on the Great Falls Campus

Bozeman and Northern students use our campus. Both schools issue them their ID cards and take care of any student information in SIRSI.

Community Borrowers

Community borrowers don't come by very often, but they are required to present their community borrower card and a photo ID before checking out items. Check the expiration date in Sirsi. If card has expired, please have patron fill out a new application form, as some changes have been made.

PATRONS: Computer Lab Access

All MSU Students

Great Falls College MSU Students -
Username – NetID (a22b333)
Password – NetID Password (same as D2L)

If students cannot log in, have them reset their password at the front desk (or other public computer) at password.gfcmsu.edu

MSU-Bozeman –
Username - MSU\NetID
Password – NetID Password

MSU-Northern –
Username – MSU-northern\NetID
Password – NetID Password

MSU-Billings –
Username – msubillings\NetID
Password - **DEFAULT PASSWORD: last six digits of student ID

If Bozeman, Northern or Billings students have problems, they need to contact their “home” helpdesk. There are hompages to change passwords as well that you can try to help them with.

If there is NO possible way to log a student in to the computer lab, there is a generic login. DO NOT share this with students, just type it in.

PATRONS: Courtesy Borrower

Creating a Courtesy Borrower Card:

When a member of the public wants a “Courtesy Borrower Card”, the person needs to produce a picture ID and something that would verify current address (utility bill, voter’s registration card, etc). First, check the Barred List in the inside front of the Courtesy Borrower Card Applications binder (white binder) which is located in the bottom drawer to the right of the circulation computer AND check Sirsi to make sure the “community borrow” is not a student. If the person is not listed and does not have a record in Sirsi already, have the individual complete a Courtesy Borrower form from the binder. There are forms in the Courtesy Borrower Card Applications binder.

There are key tags in the drawer to the left of the Circulation computer. Check all information on the completed form; list the Borrower’s card number, date, sign, and place in the grey notebook **alphabetically by patron’s last name**.

Tell the patron that the card and a picture ID must be presented for each check-out.

Follow the illustrated steps to add the Community Borrower to Workflows:

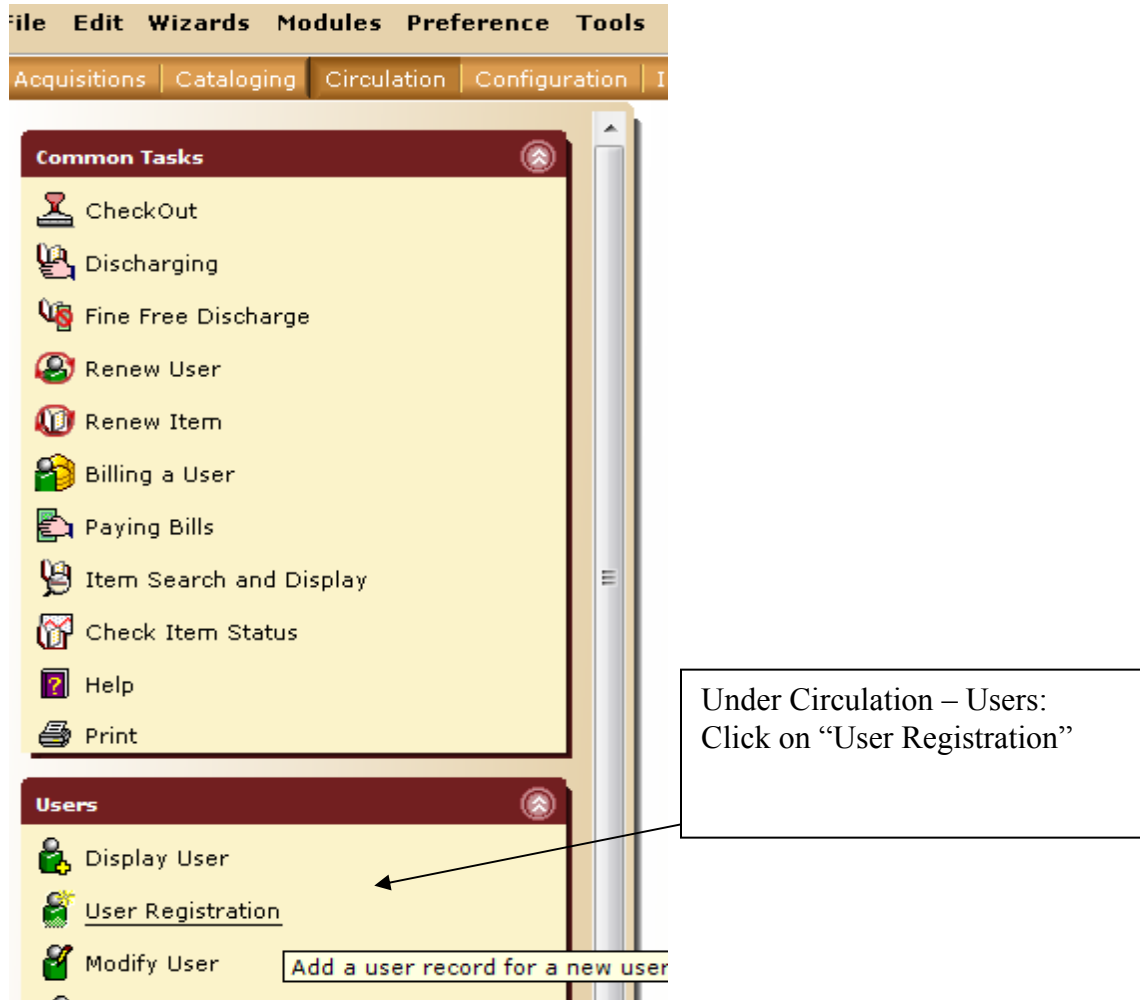

User Registration : Identify New User

User ID:

Profile name: PUBLIC

- GF-ADMIN
- GF-COURTES**
- GF-FACSTAF
- GF-ILL
- GF-LIBUSE
- GF-SCIRC
- GF-STAFF
- GF-STUDENT

Cancel

Enter the patron's ID number from the Community Borrower Card.

Use the drop-down arrow to select GF-Courtes (Courtesy) Click "OK"

User ID: 69722222 **NAME-NOT-YET-SUPPLIED** Profile name: GF-COURTES...

Basic Info Privilege Demographics Addresses Extended Info

Last name, first: ****NAME-NOT-YET-SUPPLIED****

Title:

Alt ID:

Group ID:

Library: GREATFALLS

Profile name: GF-COURTES

Type the patron's last name, first name. Make sure that the Library and Profile name are set correctly.

Basic Info Privilege Demographics **Addresses** Extended Info

Primary: Address 1 Address 2 Address 3

Address 1

HOMEPHONE

DAYPHONE

LINE

STREET

CITY/STATE

ZIP

EMAIL

LOCATION

Click on the Address tab, and add the phone number and address.

Basic Info | **Privilege** | Demographics | Addresses | Extended Info

Privilege expires: 

Password: Override:

Status: 

Claims returned:  Override:

Web auth id: Override:

The "privilege expires" date should automatically set for one year from the date of issue.

Next, click the "Register User" button.

OPENING

Turn on lights by the front doors. If by chance they do not turn on, contact Dave Bonilla in the IT Department.

Record the gate count; sheet is located by the phone at the circulation desk. Counter is located on the inside of the far left gate.

Check the stapler's staple supply and make sure the staple remover, 3-hole punch, paper cutter, etc., are on the table next to the copier.

Turn on the computers and printers; check each printer for paper.

Turn on the Circulation computer

Login:

Password:

- Double click the Workflows 3.2J icon

Login:

Password:

Turn on the two Reference computers:

Login:

Password:

- Double click on the Workflows 3.2J icon

Login:

Password:

- On the reference computer at the circulation desk, please open Outlook and maximize on the screen.

Great Falls Tribune should be on the Library Tech's desk.

- Check newspapers into Sirsi Workflows

Turn on cash register (key should be left in register).

Get keys from the top drawer in the cabinet behind employee work area.

- Unlock cash drawer on register.
- Open doors.
- Check book drop in Atrium.

Put the keys back in the top drawer behind employee work area.

CLOSING

Fifteen minutes before the library closes, notify all patrons that the library will be closing. Also, remind anyone using computers about automatic shutdown of the machines. (Computers shut down 5-minutes prior to closing)

Get keys for the cash drawers and book return from the top drawer behind employee work area.

Push in chairs. Check study cubicles for any books or papers that might have been left by students.

Shelve any books, magazines and/or newspapers that are on the tables.

Check book return in Atrium and check in any materials in the book drop.

5 minutes before closing, start turning off printers.

Student Library/Lab Computers:

- Be sure to check for any discs or pen drives that students might have left in the computers.
- Turn off the printers and close their paper trays.

Staff Computers:

- Do not turn off the Circulation Desk computer until the doors are closed.
- On the Reference Desk computers exit all programs, including: outlook and SIRSI Workflows and shut down the computer.

Walk around in back to check for remaining patrons in study carrels and rooms.

Lock cash drawer and turn off register. Leave operator key in register.

Close the SIRSI Workflows program and shut down the Circulation computer.

Record the gate count; the record sheet is located by the phone at the circulation desk. Counter is located on the inside of the far left gate.

Put the keys back in the top drawer in cabinet behind employee work area.

Turn off the lights. If lights do not shut off, leave a message for Dave Bonilla in the IT department.

Make sure the doors are locked after exiting.

Just in case:

Custodian cell phone: 8-788-1188 or Campus Security 8-788-2252 or emergency 911

WEAVER LIBRARY PROCEDURE MANUAL

Student Worker

eLearning and Library Services Student Worker Job Description

Employment Application

Student Employee Manual General Information – Remainder can be read in the
Student Employee Manual binder on the back counter.

Job Title

eLearning and Library Services Student Worker

Job Description

Provide basic customer service to students and the public in a courteous manner. Monitor the computer lab, assist in computer and software use, troubleshoot computer and software programs, and explain how to access and navigate in the Desire2Learn (D2L) learning management system. This employee will cross train between eLearning and the Library and will be scheduled to work in both departments. The first priority for eLearning employees is assisting students enrolled in courses using D2L. Additional tasks required while working in the Library include checking library items in and out, shelving library materials, shelf reading, and processing new library materials and periodicals. Responsible for enforcing eLearning and Library Services (as well as campus) computer lab policies and completing special projects and other tasks as assigned. Hours vary, but could include evenings and weekends up to 20 hours per week.

Qualifications

Student employees must be enrolled in a minimum of 6-credits and are limited to working a maximum of 20 hours per week. Work-study and non-work-study eligible students may apply. A positive attitude, attention to detail and reliability are required; and this employee must be a service and team-oriented individual. Preference is given to students who have completed Introduction to Computers or an equivalent class with at least a "B" and have taken an online class or utilized D2L. Must have basic computer skills, the ability to work well with the public and other staff, and be able to work in a busy environment with frequent interruptions. Activities include walking, sitting, light lifting, reaching, bending over, writing, hearing, speaking and seeing.



GREAT FALLS COLLEGE
MONTANA STATE UNIVERSITY

**eLEARNING &
LIBRARY SERVICES**

Student Employee Manual General Information

Table of Contents

General Information	4-11
Introduction	4
Job Description	4
Qualifications.....	4
Schedules	5
Attendance	5
Payroll and Time Sheets	5
Breaks.....	5
Staff Wiki	6
Compliance with eLearning and Library Services and College Policies	6
Computer Access	7
Student Employee Expectations	8
Training and Evaluations	9
Example Training Form	10
Example Evaluation Form	11
Weaver Library - General Duties	12-18
Weaver Library General Duties	13
Numbers to Remember	14
Telephone	14
Security System	14
Cash Register	15
Transaction Costs	16
Changing Toners	16
Problem Patrons	16
Emergencies.....	16
Opening Procedures.....	17
Closing Procedures	18
Weaver Library – Circulation of Materials	19–22
Checking Out Materials	20
Discharging Materials.....	21
Renewing Materials.....	22
Manual Checkout Procedure	22
Weaver Library – Processing Materials.....	23–34
Processing Periodicals	24
Processing Books.....	25-29
Processing Videos.....	30-31
Processing DVDs	32-33
Physically Processing Books or Journals for Discard	34
Weaver Library – Shelving Materials.....	35-38
eLearning – Mission and Vision Statement	39
eLearning General Duties.....	40-42
Customer Service.....	42

Telephone Etiquette.....	42-43
eLearning - Orientation to D2L.....	44-48
Logging into Banner Web	44
Creating D2L / Network / Student Email Password.....	45
Activating Student Email Account.....	45-46
Network Accounts.....	46
D2L Online Orientation.....	46-47
Getting Help and Knowing Where to Find It.....	47-48
eLearning - Computer Use in eLearning.....	49
Routine Duties	50
Closing the eLearning Office	50
eLearning – Data Tracking	51-53
eLearning – Bulk Mail.....	54-62

Introduction

This manual is designed to provide a general overview of policies and procedures for student employees in eLearning and Library Services. All student employees will be required to review the manual. If you have questions regarding anything contained in this manual, please ask your supervisor.

As a student employee in this department, you are expected to be professional – this means being dependable. This position is vital to the smooth daily operations of eLearning and the Weaver Library and you are expected to exhibit a strong work ethic – that means being responsible and showing attention to detail in your work. Finally, we expect you to come to work with a positive attitude – this means being friendly, patient, and helpful to both patrons and other employees; it also means being willing to complete assigned tasks.

Student employees must be enrolled in a minimum of 6-credits and are limited to working a maximum of 20 hours per week.

Job Description

Provide basic customer service to students and the public in a courteous manner. Monitor the computer lab, assist in computer and software use, troubleshoot computer and software programs, and explain how to access and navigate in the Desire2Learn (D2L) learning management system. This employee will cross train between eLearning and the Library and will be scheduled to work in both departments. The first priority for eLearning employees is assisting students enrolled in courses using D2L. Additional tasks required while working in the Library include checking library items in and out, shelving library materials, shelf reading, and processing new library materials and periodicals. Responsible for enforcing eLearning and Library Services (as well as campus) computer lab policies and completing special projects and other tasks as assigned.

Qualifications

Work-study and non-work-study eligible students may apply. A positive attitude, attention to detail and reliability are required; and this employee must be a service and team-oriented individual. Preference is given to students who have completed Introduction to Computers or an equivalent class with at least a “B” and have taken an online class or utilized D2L. Must have basic computer skills, the ability to work well with the public and other staff, and be able to work in a busy environment with frequent interruptions. Activities include walking, sitting, light lifting, reaching, bending over, writing, hearing, speaking and seeing.

Schedules

Hours vary, but could include evenings and weekends up to 20 hours per week.

When submitting your schedule requests, clearly indicate which hours you are and are not willing to work. When your supervisors assign work shifts, they will try to accommodate preferred hours to balance your requested hours with the needs of the department.

Schedules are effective throughout the semester with adjusted changes for finals week. You are required to work all assigned shifts during this time. Failure to do this could result in termination. Please be aware of this when considering your plans. Approved absences will only be given for scheduled final exams or emergencies.

Attendance

Please report promptly for your scheduled work shifts. Your lateness will impact other employees. You cannot work on a day you are absent from classes.

If you are unable to work, call the Library at **771-4398** before your shift begins as early as possible. All absences must be approved by your supervisor. Assistants are responsible for finding a replacement for any preplanned absence.

The smooth operation of the division depends on its employees showing up and working during their scheduled times. Therefore, after one unexcused absence during a semester you will be on probation and a second unexcused absence will result in automatic termination of your employment. Unexcused tardiness is also unacceptable. Tardiness is defined as 5 or more minutes late. Three tardies equal one absence. While we want to be flexible, due to the needs of the eLearning and Library Services, excessive or continued requests for schedule changes may result in termination.

Payroll and Time Sheets

You will be paid every two weeks on Fridays. Your time sheet is due on paydays; please have it submitted on Banner Web. It is very inconvenient for the payroll clerk when you turn your time sheet in the following Monday. Checks will be ready for you to pick up at the payroll office; if you set up direct-deposit, your pay stub will be available on Banner Web.

Each day you should record the hours worked on your assigned time sheet. You are responsible for recording your own hours. Time sheets should be submitted through Banner Web by Friday.

Breaks

Student employees are allowed a 15-minute break for each 4 consecutive hours worked. You are not permitted to combine your breaks and leave early from a shift. You will not be allowed to work more than 4 consecutive hours without a mandatory 30-minute break.

Staff Wiki

This space is designed with the intention to improve communication between full-time staff members and student workers. You will find updated information on important notices that need attention, technology/software issues, Student worker task information, Student worker schedules, etc. Please check this site daily for any updated information.

The website is <http://weaverlibrarystaff.pbworks.com>. Your username and password was given to you during training. In the event that you no longer have access to this information, please see Kirsten so she can reset your password.

Compliance with eLearning and Library Services and College Policies

You are expected to comply with eLearning and Library Services as well as College policies. See the College catalog under “General Information” and “Student Information” for current College policies.

Both the department and the College have confidentiality requirements; in eLearning and Library Services, all patron interactions, check-out records, personal information, etc. must be kept confidential. You will be required to watch the FERPA video and sign the confidentiality form.

The Montana State Board of Regents has a policy on user responsibilities for information technology. These policies differ for computer labs/classrooms and libraries. Libraries have some exceptions because of research/intellectual freedom issues and also because the libraries are open to the public as well as staff and students.

We ask that you refrain from changing the configurations/settings on any computer or accompanying software.

Please become familiar with:

- Montana Board of Regent’s computer policy at
 - <http://mus.edu/borpol/bor1300/bor1300.asp>
- Campus Policies
 - <http://www.gfcmu.edu/about/PoliciesProcedures/index.php>
- Weaver Library Policies
 - <http://www.gfcmu.edu/about/PoliciesProcedures/900Policies.php>

Computer Access

The library student computer lab and eLearning computers are only for use by registered MSU (Bozeman, Northern, Great Falls)-students, faculty, and staff. Library public computers are available to students and the public primarily for research. MSU students will have their own login and cheat sheets are available at the circulation desk in the library.

Examples of the various MSU logins include:

Great Falls

Username: NetID

Default Password: D2L password

**Students are now able to change/reset their own passwords at <http://password.gfcmsu.edu> **

Bozeman

Username: MSU\NetID

Password: Their MSU password

The **MSU needs to be typed exactly as shown. If students are having issues, they need to contact the Help Desk at MSU-Bozeman or visit <http://password.montana.edu/> **

Northern

Username: MSU-northern\NetID

Default Password: D2L password

The **MSU-northern needs to be typed exactly as shown. If students are having issues, they need to contact the Help Desk at MSU-Northern or visit <http://msun.edu/passwords.htm> **

If necessary, the generic login information:

Library

Username: liblab

Password:

Distance

Username: distance1

Password:

Student Employee Expectations

1. The first priority for student workers is to assist patrons in a courteous manner.
 - a. Be aware of your surroundings in eLearning or Library Services (depending on where you are working) and be cognizant of patrons in the room. If you see they may be in need of assistance, approach them and offer your help.
 - b. Remember you are working in a shared office space and should refrain from excessive chit chat and visiting with fellow classmates while on duty.
2. FERPA – Everything seen or heard in the offices, including (but not limited to) all student information, is strictly confidential.
3. Become familiar with eLearning and Library Services
 - a. Utilize the Wiki frequently (daily)
 - b. Know your way around D2L as well as Sirsi
 - c. Know phone numbers of appropriate staff and who to contact for various issues.
4. Be pro-active in learning campus details – including website, catalog, staff, departments, events, services, etc.
5. You are expected to complete work as assigned and assist students prior to doing homework.
 - a. You have to be able to be interrupted frequently in order to maintain quality customer service.
 - b. Ask staff if there are any projects and check the wiki prior to starting homework.
 - c. Consider this a privilege as most departments don't allow homework opportunities. However, abuse of this privilege may result in it being taken away.
6. When unable to work a scheduled shift, it is your responsibility to find a replacement (if known ahead of time).
 - a. If you are running late for work or unable to make your shift due to illness or other emergency, please call **771-4398**.
7. Student workers should **NOT** make personal phone calls while on duty unless they are on break, or need to take an emergency call for family or other related issues.
8. Student workers are **NOT** permitted to wear headphones while on shift. We want our student workers to appear approachable and ready to assist, and unfortunately wearing headphones does not convey that image.
9. Please ask questions at any time to any of the eLearning or Library staff if you are unsure of policies and procedures. Our offices are open any time, so please do not hesitate.

Training and evaluation

Your first few shifts will involve on-the-job training; the time needed to complete your training checklist will vary depending on your experience and your work hours. Remember, if you have questions about specific duties or procedures at any time, ask your supervisor. Be sure to ask if you want to review instructions at any time.

Job performance will be evaluated sometime during each semester. Evaluation will be based upon whether your job performance meets the department's expectations. Students who fail to meet job expectations may be terminated. Evaluations will not be released to any person or agency outside the MSU-Great Falls College of Technology, but are kept on file for review by your supervisor and administration.

During your shift, you are expected to do assigned work. You may only do homework if there is no job-related work to do and with the approval of your supervisor. Your first priority is always being available for students and to watch for those who may need help. Students should not have to leave their computer stations to ask for help.

Student Employee Training

Name _____

First and Final Check-off Initialed by two different Staff members **only when instruction is completely understood**

Introduction to eLearning and Library Department:

- _____ Personnel Processing
- _____ Go over timesheets
- _____ eLearning and Library Department tour and rules
- _____ Confidentiality (FERPA video)
- _____ Customer Service
- _____ Answering phones
- _____ Student Passwords
- _____ Wiki Training
- _____ Read Student Worker Manual

Weaver Library basics:

- _____ Daily tasks for Computer Lab/Library Assistant (Include photocopier and tool table etc.)
- _____ Printers
- _____ Headphones/ Zip Drives/ Machine Transcription
- _____ View "Initial Tutorial" and complete quiz
- _____ Cash Register
- _____ Security gate

eLearning basics:

- _____ Pre-register for D2L Student Resource Course
- _____ Watch D2L Training Videos
- _____ Read D2L Manual
- _____ Attend and Assist with D2L orientations and/or Role Playing

Weaver Library tasks:

SIRSI:

- _____ Review Section "Checking Items In and Out" in the Student Worker Manual.
- _____ Checking in/out items - preceding "8" for COT and "9" for BZ & N
- _____ Laptops - Circulation procedures and signature verification process

Processing:

- _____ Review Section "Processing Materials" in the Student Worker Manual
- _____ View "Processing Tutorial" and complete quiz
- _____ Practice processing Books and Serials

Shelving:

- _____ Review Section "Shelving" in the Student Worker Manual
- _____ View "Shelving Tutorial" and complete quiz
- _____ Library of Congress Call Numbers
- _____ Practice shelving books and serials
- _____ Serial Shelving Maintenance and shelf reading

Evaluation:

- _____ Questions from prior instruction
- _____ Evaluation after training
- _____ Follow-up Evaluation one month after training

STUDENT EMPLOYEE PERFORMANCE EVALUATION

Student's Name: _____

Employer/Department: _____

Review Period: _____ to _____

Instructions: Fill in the circle that corresponds to each statement. Review the evaluation with the student and obtain his signature. Retain a photocopy for the student's file with the employer/department. The original must be submitted to the Payroll Office.

		Unsatisfactory	Needs Improvement	Satisfactory	Above Average	Outstanding
QUALITY OF WORK	Accurate and thorough in job duties.	<input type="radio"/>	<input type="radio"/>	<input type="radio"/>	<input type="radio"/>	<input type="radio"/>
JOB KNOWLEDGE	Understands procedures required in job.	<input type="radio"/>	<input type="radio"/>	<input type="radio"/>	<input type="radio"/>	<input type="radio"/>
USE OF TIME	Effective and efficient use of time to accomplish work tasks.	<input type="radio"/>	<input type="radio"/>	<input type="radio"/>	<input type="radio"/>	<input type="radio"/>
JOB JUDGMENT	Exercises sound judgment.	<input type="radio"/>	<input type="radio"/>	<input type="radio"/>	<input type="radio"/>	<input type="radio"/>
ADAPTABILITY	Ability to alter work tasks, activities, plans, etc., to accommodate change.	<input type="radio"/>	<input type="radio"/>	<input type="radio"/>	<input type="radio"/>	<input type="radio"/>
INITIATIVE	Ability to initiate work with minimal supervision.	<input type="radio"/>	<input type="radio"/>	<input type="radio"/>	<input type="radio"/>	<input type="radio"/>
INTERPERSONAL RELATIONSHIPS	Effectively works with co-workers, supervisors, and the public.	<input type="radio"/>	<input type="radio"/>	<input type="radio"/>	<input type="radio"/>	<input type="radio"/>
DEPENDABILITY	Reliable in completing tasks and keeping supervisor advised of progress.	<input type="radio"/>	<input type="radio"/>	<input type="radio"/>	<input type="radio"/>	<input type="radio"/>
ATTENDANCE	Reports to work regularly and keeps supervisor advised of schedule changes.	<input type="radio"/>	<input type="radio"/>	<input type="radio"/>	<input type="radio"/>	<input type="radio"/>
PUNCTUALITY	Conforms to work schedule; arrives at work promptly and ready to work.	<input type="radio"/>	<input type="radio"/>	<input type="radio"/>	<input type="radio"/>	<input type="radio"/>

COMMENTS:

AREAS NEEDING IMPROVEMENT:

Supervisor's Signature: _____ **Date:** _____

Student's Signature: _____ **Date:** _____

I DO / DO NOT recommend the student for a wage adjustment based on performance this period.
(please circle one)



GREAT FALLS COLLEGE
MONTANA STATE UNIVERSITY

WEAVER LIBRARY

General Duties and Tasks

Weaver Library – General Duties

1. At the start of your shift, please fill staplers and paper trays for the photocopier as needed. Pick up any loose paper and soda cans and recycle. Patron items (documents, discs, etc.) that are found should be brought to the library front desk lost & found. Check-in, re-sensitize, and shelve materials that have been left in the book drop.
2. Monitor the computer lab:
 - Help with software issues and technology is expected; for help with completing assignments, students should be referred to the learning center or their instructor.
 - Walk through the computer lab frequently (be visible for questions or to assist students). Keep an eye on the library computers/printers as well.
 - The Library Computer Support Specialist (Benjamin) is responsible for anything beyond the basics – unless you have been given authorization.
3. Monitor group study rooms. Ensure that students are not just using the study rooms as storage space. Clean up any messes and remove any equipment as necessary.
4. Answering students' library related questions should follow these guidelines: Answer direction questions (ie, where are the phonebooks?), but refer the "how" questions (ie, How do I find a book on muscular dystrophy? Or How do I find an article in a database?) to a member of the library staff.
5. Check the Library Wiki for additional duties or special tasks.
<http://weaverlibrarystaff.pbworks.com/w/page/30553536/Weaver-Library-Staff-Wiki>
6. What to do when there is nothing to do:
 - a. Greet patrons entering the library. Often a friendly greeting will lead to a question from the patron.
 - b. Tidy the library and computer lab.
 - c. Clean computers and tables in both the computer lab and rest of the library.
 - d. Fill the photocopier paper tray, add staples in stapler, and empty the hole-punch tray.
 - e. Re-sensitize and/or shelve appropriate materials.
 - f. Process new materials and shelve as needed.
 - g. Always check on patrons regularly, to see if any help is needed. Keep an eye out for people who look lost or frustrated and ask if they need help.
 - h. Ask the library staff for work that needs to be done.

Numbers to Remember

Incoming and Outgoing Mail duties (324210 in upper right hand corner)

Telephone

Answer the telephone by saying “MSU Great Falls Weaver Library, ___ speaking. May I help you?”

If the call is for a Library staff member, answer “Just a moment, please.”

If the Library staff member is busy or not in the office, always answer the phone “ ___ is not available, may someone else help you?”

Never tell a caller if the staff member or work study is on/off duty, when a person is scheduled to work, if someone is out of the office, or where a staff member/ work study is located in another part of the campus. If the Library staff member is assisting a patron, ask the caller if he or she would like to talk to another staff member or have the Library staff member return the call as soon as possible. Be sure to record on any message the date, time, the caller’s name, phone number, whether the caller will call back or if the call should be returned, any other pertinent information, and initial the note.

To transfer phone calls to another extension, press “Transfer” then enter the 4-digit extension number and press “Transfer” again.

Security System

Responding to the alarm - The security gate is designed to prevent theft of library materials. If the alarm goes off, ask the patron to return to the counter. Ask a courteous question such as “Excuse me, did I forget to check out one of your books?” -or- “Did you accidentally pick up one of the library’s books with your own things?” -or- “Do you have any books from another library or from the book store that you recently purchased?” Because a variety of innocent reasons can set the alarm off, we never want to accuse a patron of theft.

Process and desensitize all items again. If you discover an item that wasn’t properly checked out, never accuse the patron of stealing. It was probably an oversight.

Unwanted alarms - If the following items have active security strips, they may cause unwanted alarms:

- Books from another library or book store
- Audio and video cassettes from video rental and music stores
- Other items from retail stores

When an active strip on an item from outside our library caused the alarm, explain the problem to the patron. Verify that all of the patron’s library materials are checked out and allow the patron to leave the library.

Cash Register

All Transactions EXCEPT fines and found

1. Type in your assigned clerk number (black numeric keys)
2. Press CLK# key
3. Type number sold (black numeric keys)
4. Press @/FOR key
5. Choose object sold (white numeric keys)
 - a. 1 = paper
 - b. 2 = Color print
 - c. 3 = Fax
 - d. 4 = Fines
 - e. 5 = Paper Packets
 - f. 13 = Found
6. Press #/TM SBTL key
 - a. Display will show subtotal
7. Type amount of money given by patron (black numeric keys)
8. Press CA/AT/NS key
 - a. Display shows change owed and cash drawer opens
9. Give change if any and close cash drawer
10. Press CLK# key twice to log off

Fines and found

1. Type in your assigned clerk number (black numeric keys)
2. Press CLK# key
3. Enter fine amount or amount found (black numeric keys)
4. Choose fines (#4 white numeric key) or found (#13)
5. Press #/TM SBTL key
 - a. Display will show subtotal
6. Type amount of money given by patron (black numeric keys)
7. If patron pays with check, press CHK key
8. If patron pays with cash, Press CA/AT/NS key
 - a. Display shows change owed and cash drawer opens
9. Give change if any and close cash drawer
10. Press CLK# key twice to log off

Transaction Costs

Paper — Paper is sold for 10 cents a sheet or \$1.00 per packet

Fines — Any fine transactions should be referred to Library staff members.

Fax — Faxing costs are \$1.00 per page.

Color Print — Color printing costs \$0.25 per page. They do not need to supply their own paper for printing in color.

Change — Change can be made for the copier. Use your clerk number and the “CA/AT/NS” Button to open the drawer.

Check Cashing — **DO NOT CASH CHECKS.** We only accept checks when someone is paying a fine or for **amount of purchase** only on weekends (as nothing else is open on campus to do make such purchases).

Canadian Money — We **CANNOT** accept Canadian Money. The Business Office will not accept foreign currency.

Changing Toners

When a printer toner cartridge needs to be changed, the replacement cartridge is located in the left side of the “island”. Write down the date on the sheet attached to the Toner box.

Problem Patrons

Problems with patrons - if a patron has been asked to refrain from an activity that is not allowed and that patron refuses to comply please get one of the full-time staff members to assist you.

Emergencies

Emergencies – Become familiar with the Campus Emergency Procedure Manual as well as the eLearning and Library Services Emergency Procedure Manual. There is a copy of the Campus Emergency Procedure Manual in the blue “Front Desk” folder as well as the bulletin board by the front door. There is a copy of the eLearning and Library Services Emergency Procedure Manual included in the print version of the Student Manual. There are also copies placed in the left drawer of the student worker station and near the “Front Desk” folder.

Opening Procedures

- Turn on lights (located by front doors). If they do not turn on, contact Dave Bonilla in the IT Department, if it's the weekend, contact the Maintenance Department at 788-1188.
- Record the gate count; the sheet is located by the Reference computer at the circulation desk. The counter is located on the inside of the far left gate and you need the "P" number.
- Turn on the copy machine and check paper supply.
- Turn on the computers and printers, making sure to open the manual feed tray of each printer.
- Check the stapler, 3-hole punch, paper cutter, etc. and clean up any messes.
- Turn on the Circulation and Reference computers. The password information is located on the base of each computer.
- Turn on cash register (the key should be left in the register)
- Retrieve keys from the top drawer in the cabinet behind employee work area
 - Unlock cash drawer on register
 - Check book drop in Atrium
 - Unlock the cabinet and drawers at the circulation desk.
- Put keys back where you found them 😊

Closing Procedures

- Fifteen minutes before the library closes, notify all patrons that the library will be closing.
- Push in chairs and check study carrels for any books or papers that might have been left by students.
- Gather any library materials and prepare them for reshelving. Shelve if times allows
- Retrieve keys from the top drawer in the cabinet behind employee work area
 - Check book drop in Atrium and check in any materials.
- About 5 minutes before closing, start turning off printers and computers.
 - Check for any discs or flash drives that students might have left in the computers
- Turn off photocopier
- Do one last check for remaining patrons in study carrels and rooms. Turn off remaining equipment.
- Lock cash drawer and turn off register. Lock drawers and cabinet at the circulation desk.
- Close the SIRSI Workflows program and shut down the Circulation computer.
- Record the gate count; the sheet is located by the Reference computer at the circulation desk. The counter is located on the inside of the far left gate and you need the “P” number.
- Put keys back in the top drawer in the cabinet behind employee work area.
- Turn off lights. If they do not turn off, contact Dave Bonilla in the IT Department, if it’s the weekend, contact the Maintenance Department at 788-1188.
- Make sure the doors are locked after exiting.



GREAT FALLS COLLEGE
MONTANA STATE UNIVERSITY

WEAVER LIBRARY

Circulation of Materials

- Checking Out Materials
- Discharging Materials
- Renewing Materials
- Manual Checkout

Checking Out Materials

***Reference items may only be checked out by Faculty and Staff. Ask a Library Staff member to assist with this.**

***If a patron wishes to check out a periodical that does not currently have a barcode, ask for assistance from Library Staff.**

1. Ask for patrons ID.
 - a. Students should have a Student ID, but any picture ID will work if they do not. Advise them to get a Student ID from Student Central when they have the chance.
 - b. Faculty/Staff rarely bring in their Staff ID. If you are unsure of who they are you can ask for any picture ID, or ask for a Library Staff member to assist.
 - c. Courtesy Borrowers should present their Library card and a picture ID. Their Library card alone is not accepted as there is no way to be sure that it is really their card.
2. Click the Checkout button (picture of a stamp).
3. In the User ID text box:
 - a. For Great Falls students, faculty and staff: type an 8 followed by the patrons ID number (without the dash).
 - b. For Bozeman and Northern students, faculty and staff: type a 9 followed by the patrons ID number (without the dash).
 - c. For Courtesy Borrowers: just type in the ID number.
4. Press "Enter" on the keyboard. The patron's name and address should appear at the top of the "User Information" dialog box.
5. With the cursor in the "Item ID" text box, scan the barcode of the requested item. Repeat for each item.
6. Each item should appear in the "List of Checkouts" area showing the items title along with the date the item is due. Write the due date on the date due post-it on the book pocket.
7. Desensitize Books, DVDs, and CDs. **Do not desensitize Cassettes, VHS, or Floppy Disks.**
8. Inform the patron of the due date as you hand them the items.

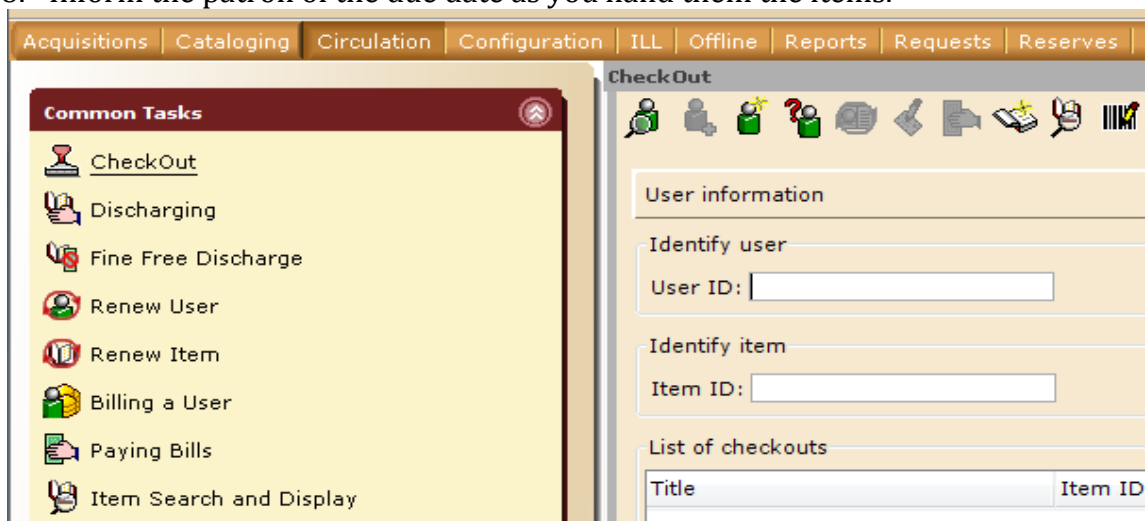

Discharging (Checking In) Materials

1. If the item is a Video, DVD, CD, Cassette, or book with accompanying CD/Disk make sure the correct item and number of items are in the case.
2. Check for any damage on item. If damage is apparent, do not check in. Refer item to a Library staff member.
3. Click on Discharging (hand with an open book). Scan the item’s barcode. When it beeps, it has been checked in.
 - a. Reserve items will have a pop-up box appear after scanning their barcode. You must click “ok” before scanning the next item.

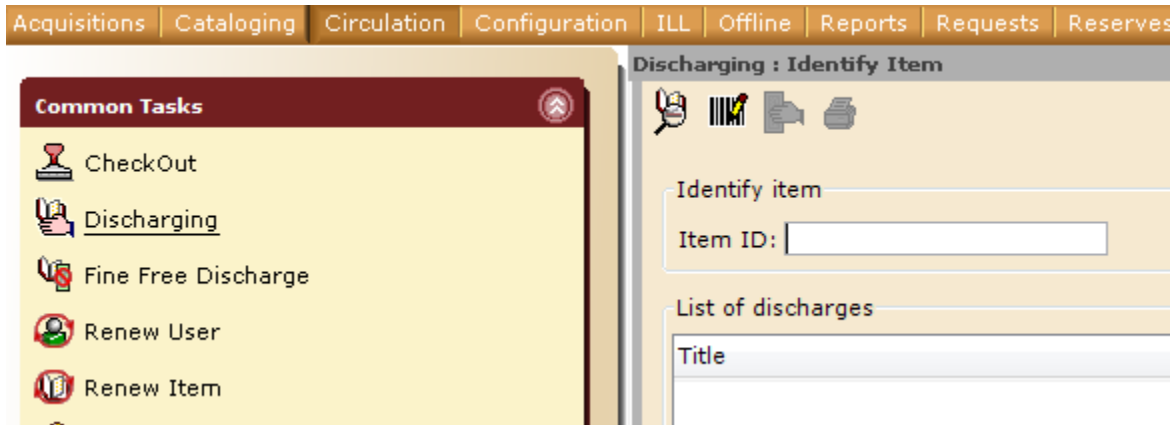

4. The Title, Item ID, Route/Transit To, Amount Billed, and Amount Paid Automatically will appear in the List of discharges area.
 - a. The Route/Transit To field will show what section of the Library the item gets shelved in (Newbooks, Reference, Curriculum, Oversize, Video, AV-Rack, Periodicals, and Reserves)

List of discharges			
Title	Item ID	Route/Transit To	Amount Billed
Another attempt at rescue	30967000409817	NEWBOOKS	

5. Continue to scan barcodes or click “Close”
6. Place returned items in the plastic box on the reserve shelf in front of Ben’s desk to await re-sensitizing and shelving.

Re-Sensitizing Materials

***Do not re-sensitize videos, cassettes, or books with floppy disks.**

1. Place the re-sensitizing unit to the spine of books and magazines or behind the book pocket of spiral bound books.
2. Hold down the button while slowly moving the re-sensitizing unit along the spine or back of a spiral bound book.
3. Place item on small cart nearby to await shelving.

Renewing Materials

Sometimes a patron wants to extend the due date of an item they already have checked out.

Renewals can be taken over the phone or in person. If you get a phone call requesting a renewal, give the phone to a library staff member until you are familiar with the procedure. If someone comes into the Library about a renewal, contact a Library staff member for assistance.

Patrons are limited to one renewal if the item does not have a hold placed on the material for another patron. The Staff member will research the item before it is renewed.

RESERVE ITEMS CANNOT BE RENEWED

Manual Checkout Procedure

The “Manual Checkout” is useful for unusual circumstances such as SIRSI not working, power outages, etc. Sometimes an item has a barcode, but the computer seems to think that the item doesn’t exist. Sometimes the checkout computer isn’t working. Use the following information to check items out to people until the computer or system is working again. If you have any questions, ask the library staff at any time.

EX:

For Journals:

Date	Patron ID	Patron Name	Barcode Number	Item Title	Month, Day, Year	Due Date	Entered in Computer?
2/14/02	01234567 CoT	Doe, Jane	331417	Chronicle of Higher Education	March 3, 2001	2/17/02	

Date	Today’s date
Patron ID	Person’s ID #, indicate COT, BZ, NO
Patron Name	Their name
Barcode Number	The barcode number of the item. Since the first eight digits are all the same, just write the last six. If it is a weird barcode, (ie. barcode begins with the letter T or those that just have 6 digits), please indicate.
Item Title	The title of the material being checked out
Month, Day, Year	If the item is a journal/magazine, please indicate the issue information.
Due Date	Calculate the correct due date, by the following rules: Books - 3 Weeks from date checked out AV Materials - 3 days from date checked out Periodicals - 3 days from date checked out Reserves - varies per item
Entered in Computer?	Leave blank. Library staff will put it into the computer.



GREAT FALLS COLLEGE
MONTANA STATE UNIVERSITY

WEAVER LIBRARY

Processing Materials

- Periodicals
 - Books
 - VHS
 - DVD
- Removing Materials

Processing Periodicals

- Property stamp:
Title Page with Contents
- Yellow Dot:
Placed on the upper left corner of the front cover; do not cover any vital information (dates, volume or issue information). The most current issue of a periodical does not get checked out, we distinguish current with a blank yellow dot, and back issues with the date (or issue number) listed on the yellow dot.
- Security tag:
Place somewhere in the middle of the magazine; try to select an inconspicuous spot like between two ads. Place the security tag into the gutter as far as possible. If you have difficulties, ask a library staff member.
- Newspaper type periodicals do not need to have security tags attached.
- Shelve the most recent date on display racks. Mark the dot of the older issue with the date of the periodical. Shelve older dated issues in the plastic holders alphabetically by name and then date order on the periodical shelves in the back.

Some current periodicals are not on the display shelf. For these issues, fill in the yellow dot and shelve these issues directly in the containers on the back shelves.

Processing Books

**It is important that all processing is completed in a consistent manner.
Take your time to complete the process correctly.**

Books with CDs/DVDs

Check disc for scratches before doing anything else. If disc is scratched or chipped, return to Library Technician.

Easy cover/laminate cover

Check the following instructional page concerning covering/laminating.

Property stamp

Top of book (use the stamp with the one line name)

Inside cover - bottom of front page (use the stamp with the address)

Title page (use the stamp with the address). The title page has the author, title, and publication information.

Security tag

Regular books – location with wide gutter

Spiral bound books – behind book pocket

CDs/DVDs – apply a round CD security tag

Videos – Place the strip towards edge on the side and cover with a special foil-lined label

Book pockets

Put book pocket inside the back cover. Center the pocket except when attaching to a paperback. With a paperback, place the book pocket off-centered towards the outside edge. **Do not use a book pocket on a Reference Book.** Don't cover any pertinent information. If there is nowhere to put the pocket inside the back cover, ask a Library Technician.

Barcodes

Barcodes are placed horizontally inside the back cover in the upper right hand corner. (See illustration on next page). Do not angle the barcode.

CD Labels & Pockets

Any book that has a CD should have "CD INCLUDED" label horizontally placed in the lower left hand corner of the front of the book.

There are plastic pockets available for CD's. Ask the technician about the location for the CD plastic pocket.

Call Numbers

Call numbers are placed on the spine (when there is room to do so) about $\frac{1}{4}$ inch from the bottom of the book. If there is no room on the spine, the call number is placed in the lower left corner of the front cover.

Call number tape is then placed over the call number.

Dots

Reference books get a blue REFERENCE dot in the upper left corner of the front.

New Books

New Books will have a yellow strip of tape with “New Book” typed on it placed below the call number

After processing, return books to the Technicians for cataloging.

Examples of Book Labels and Stamps

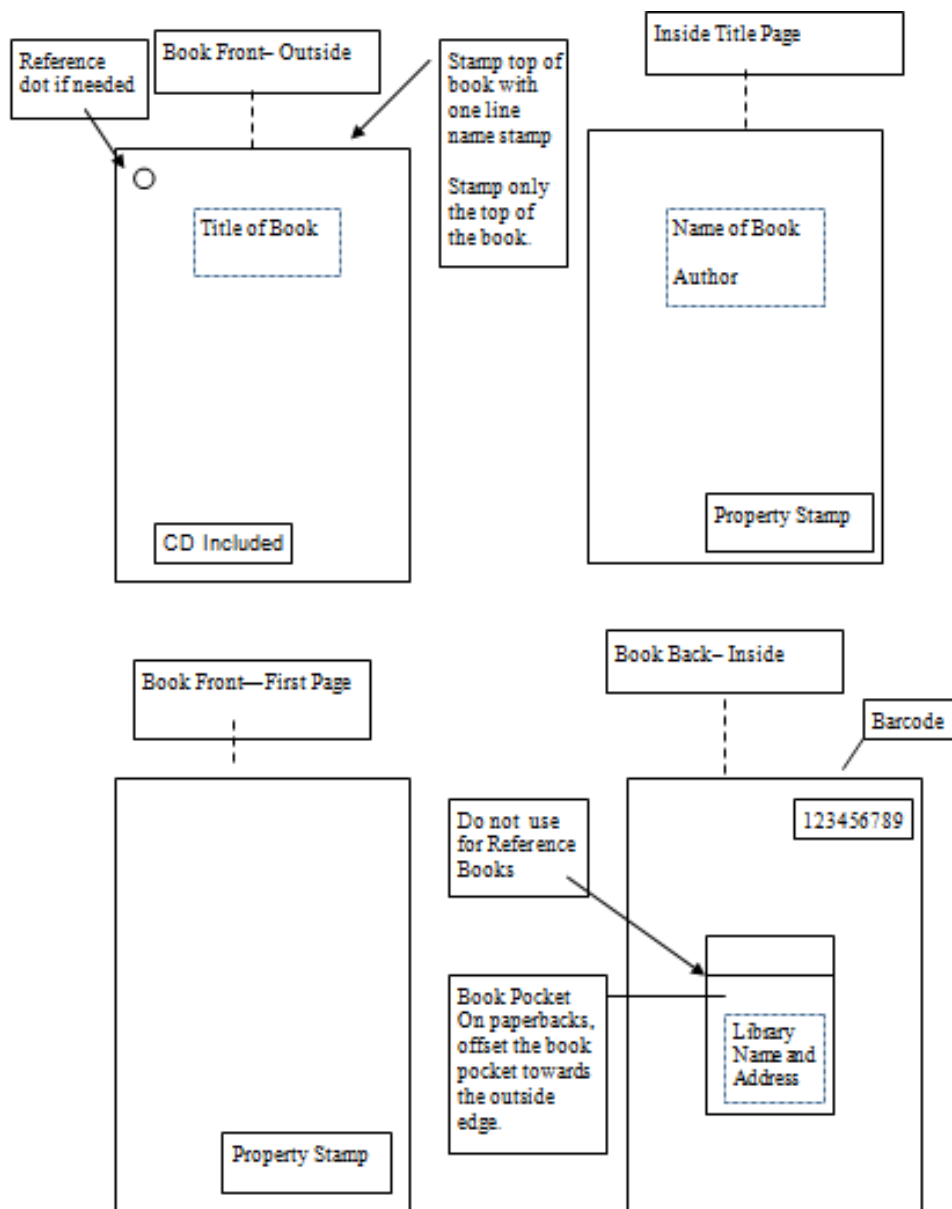

Easy Covers (Stiff Covers)

Select an appropriate size for the book that needs covering.

The Easy Covers have two pieces for each book covered. The smaller shorter stiff piece is for the back and the longer stiff piece with a flexible side portion is for the front of the book. Cover the back of the book first. Easy Covers are placed $\frac{1}{2}$ " from the back of the book spine (or spine crease).

(1) Place the Easy Cover on the table with the paper backing facing up. Be sure to align the edge of the cover against the edge of the book.

(2) Place the book against the paper backing of the back piece with $\frac{1}{2}$ " from the edge of the spine. Align the top edge of the cover with the top edge of the book. Use a fine pencil (any residue leftover can be erased), trace along the edge of the book.

3) Place the book against the stiff portion of the paper backing of the front piece with $\frac{1}{4}$ " to $\frac{1}{2}$ " from the edge of book. (The flexible portion remaining will wrap around the spine to the back of the book.) Using a fine pencil (any residue leftover can be erased), trace the top edge of the book and the open edge of the book. Do not trace the spine. Remove the book and cut the excess material off the Easy Cover.

4) ***Use the Gray Kapco Easy Trim to cut the Easy Cover.***

(5) Cover the back of the book first.

(6) Line up the Easy Cover on the front of the book. The flexible area will overlap the book spine. Remove the backing from the spine material and press it onto the spine. Finally, remove the backing from the other piece and roll the remaining front cover of the book towards the edge to avoid air pockets.

Easy Cover
steps to cover
books.

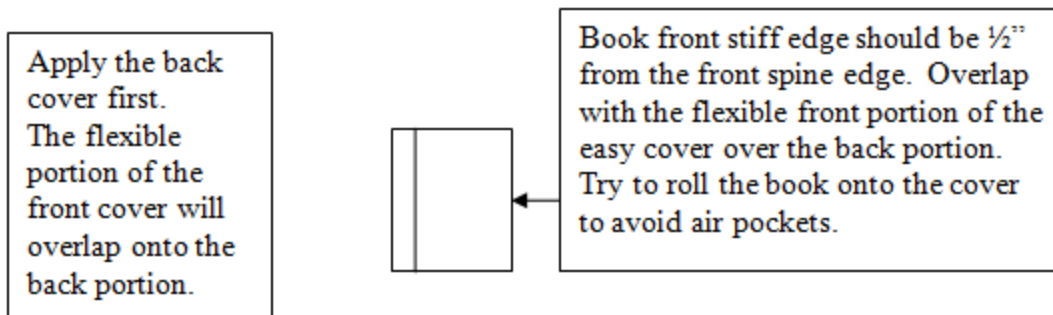
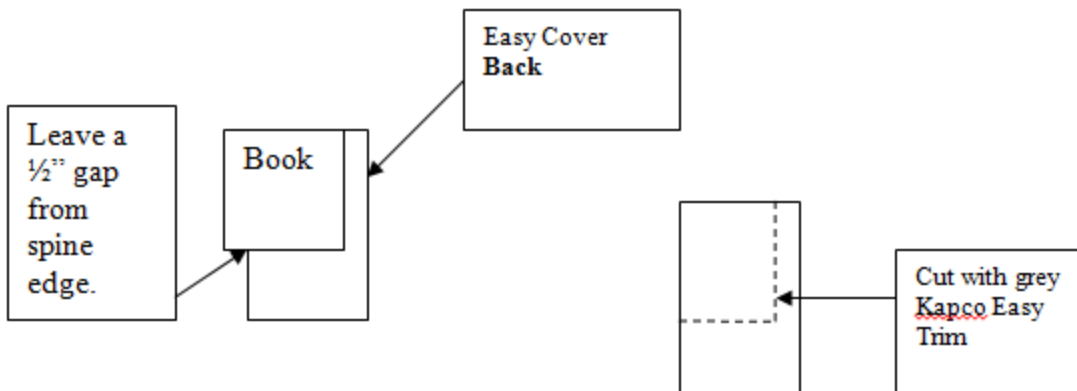
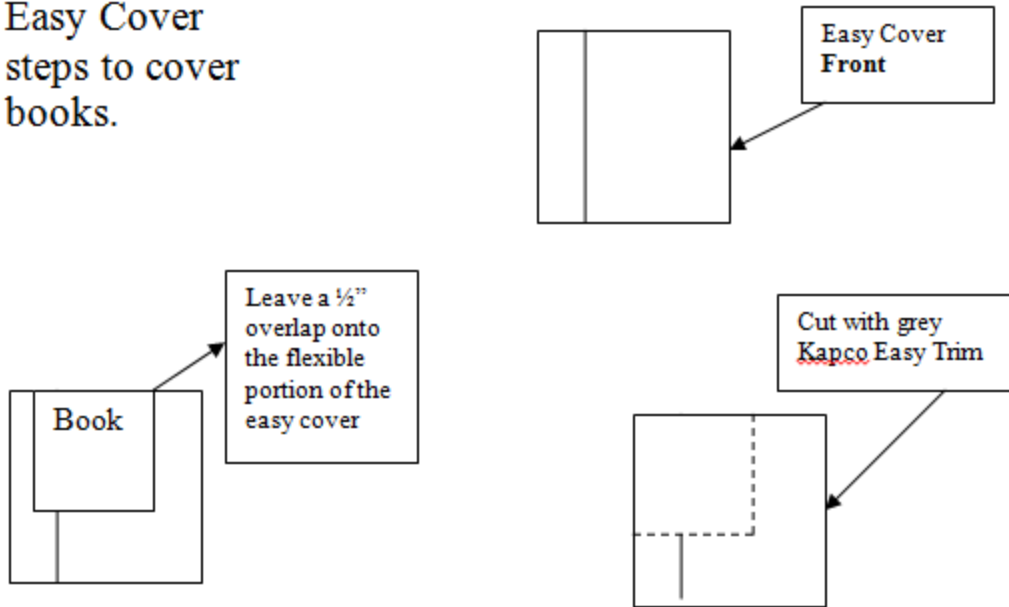

Laminating

Allow 2 spaces on small roll and 1 space on large roll.

- 1 Cut to correct size, leaving about 3cm surplus at each edge.
- 2 Remove backing paper from one half on the cut piece.
- 3 Position the book's spine in the centre, then roll the book onto the adhesive.
- 4 Cut the corners and trim film in towards the spine as shown.
- 5 Fold in surplus film. Firmly press and smooth down.
- 6 Remove backing from remaining half and repeat Steps 4 and 5.

Use the following flexible (roll) manufacturer's instructions to cover books.

Try to roll the book onto the cover material to avoid air pockets.

Be careful to align the book in a straight manner in instruction #3. This will ensure that the book cover will not be applied at an angle.

If you have any problems, be sure to stop and ask for assistance. Problems can be corrected if you stop before proceeding.

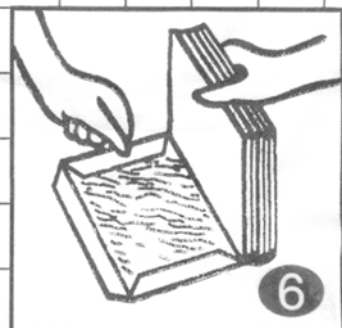
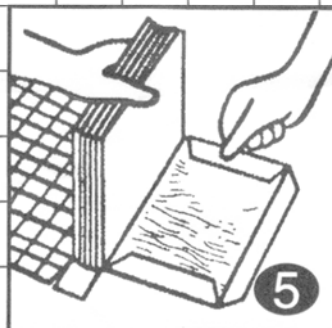
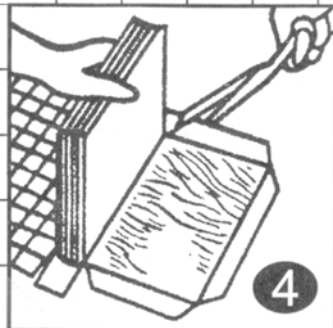
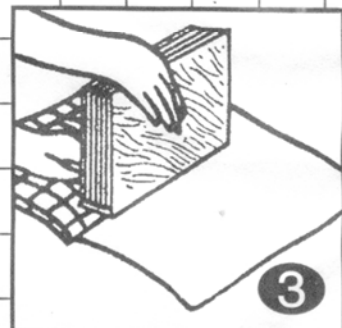
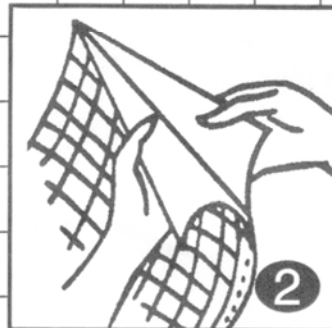
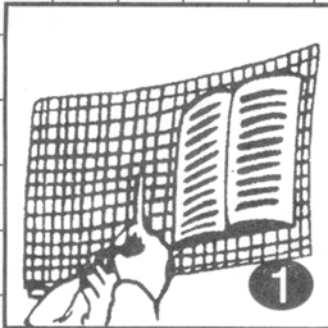

Processing Videos

Video Box

Some original video plastic boxes can be utilized. Other videos come in cardboard boxes. The Technician will decide which box should be used for processing.

If the cardboard box has a title on it, pictures, casting information, number, etc., cut the box so that it will fit in the video box sleeve. Please use the Demco cutter to obtain a clean straight cut.

If the cardboard box has nothing on it, throw it out and put the video in a plain plastic box. You will have to print out a title for it using the template in the library common drive. Open the "library/forms/forms and policies/video spine template" document to make a title for videos that go in plain boxes.

Address Sticker

Place an address sticker on the video (see picture on the illustrations on the following page for placement). Put another address sticker on the back, right corner of the video box container.

Date Due

Place the Date Due sticker on the front of the video box in the lower right corner. Address stickers are placed on the back in the right hand corner of the case.

Barcodes

Barcodes are placed on the video. See the next page to see where to attach the Bar Code.

Security tag

Videos have a special tag that is applied in two steps. The thin strip is the active tag and is placed towards the edge of the label portion on the side. A wide blank white label with a silver underside is placed over the strip to "camouflage."

Call Number Spine labels (attached by the Library Technician)

Two call number spine labels are typed for each video. One is placed on the video and the other goes on the spine of the video box. If the videos become separated from their box at any time, they then can be easily matched up again.

After processing, return videos to the Technicians for cataloging.

Video Case Processing

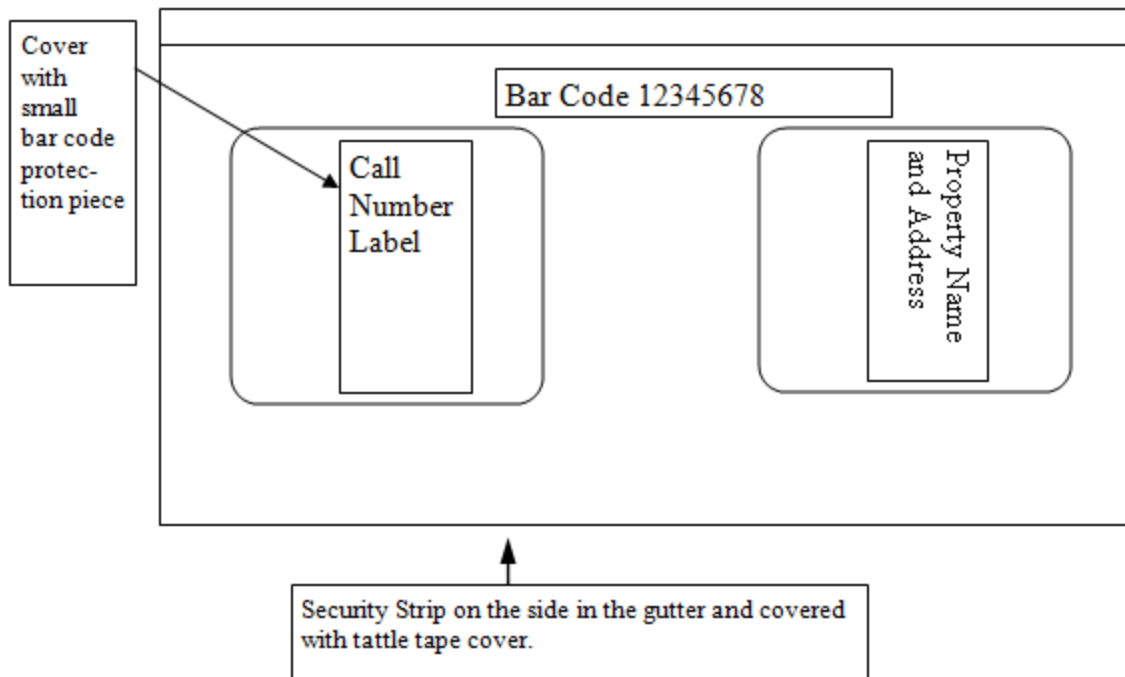
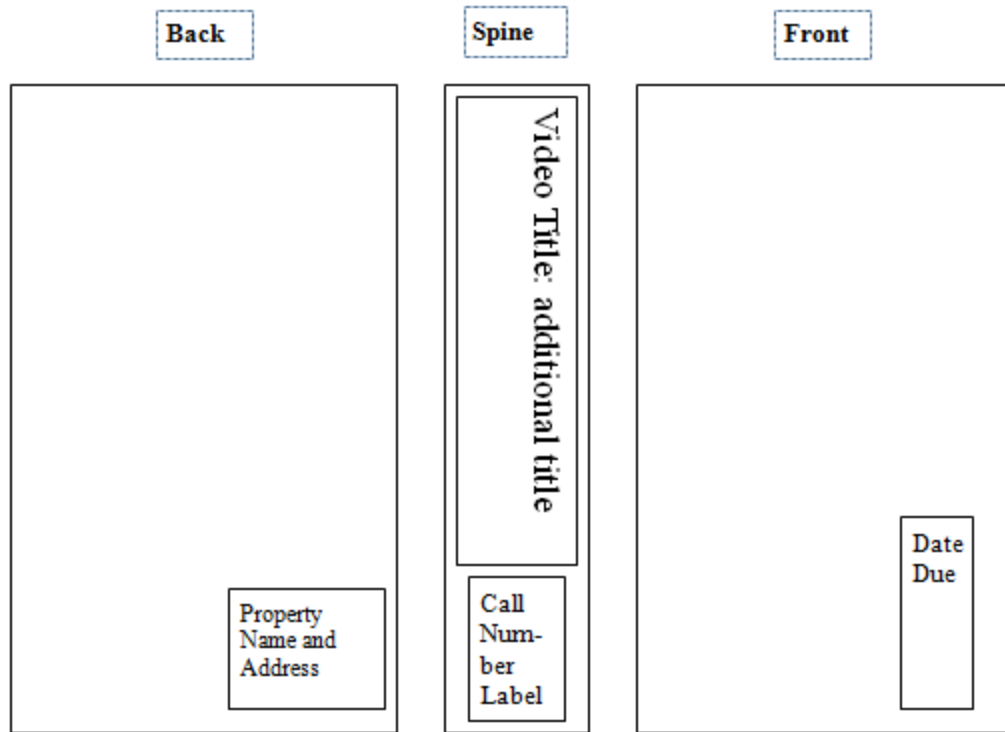

DVD Processing

Application of the Security DVD-2 Overlay

The wooden processing board (kept in a paper sack) must be used to apply the CD/DVD security overlay.

Step 1 – Clean the disc surface

- Avoid leaving fingerprints or scratches on the disc surface by handling the disc only by the edges
- Wipe the label side of the disc with a soft lint-free cloth

Step 2 – Applying the DCD-2 overlay

- Gently wipe the yellow disc portion of the CD/DVD processing board with a soft yellow cloth to remove any residue that might scratch the data portion of the disc.
 - Place the disc on the yellow pad on the processing board.
 - Align the overlay over the center hole of the disc. Decide which direction to apply the strips.
 - Securely hold the large section of the overlay near the center hole of the disc
 - Roll the small break-away portion of the overlay onto the top portion of the disc while pressing firmly back and forth across the disc
 - Repeat the steps in D to apply the remainder of the security overlay

Store the processing board inside the paper bag to reduce contaminants from gathering on the surface of the yellow pads.

Address Label

Place on back of DVD case in the lower right corner

Due Date

Place label on front of DVD case in lower right corner

Call Number

Place along spine $\frac{1}{4}$ inch from bottom of case if there is room. If there is no room on the spine, place call number on the front of the case in the lower left corner.

Barcode

Place inside case on farthest right corner, above disc.

Processing Placement Illustration

OUTSIDE FRONT

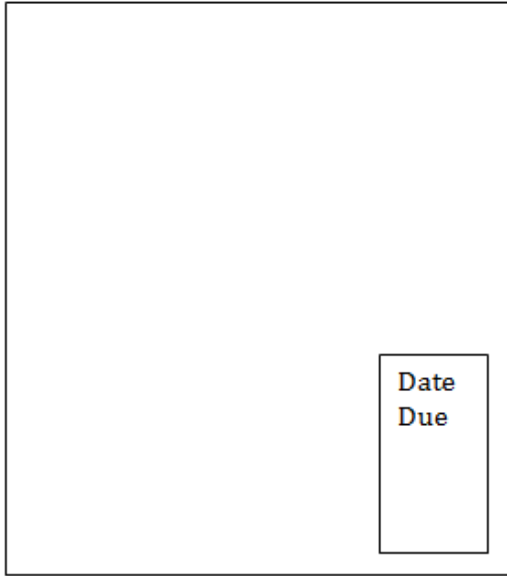

OUTSIDE BACK

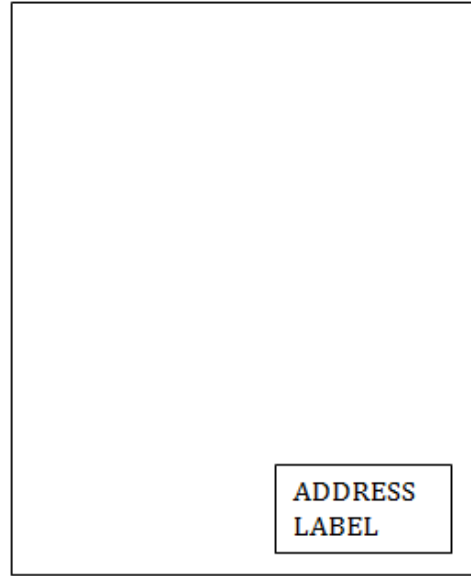

INSIDE

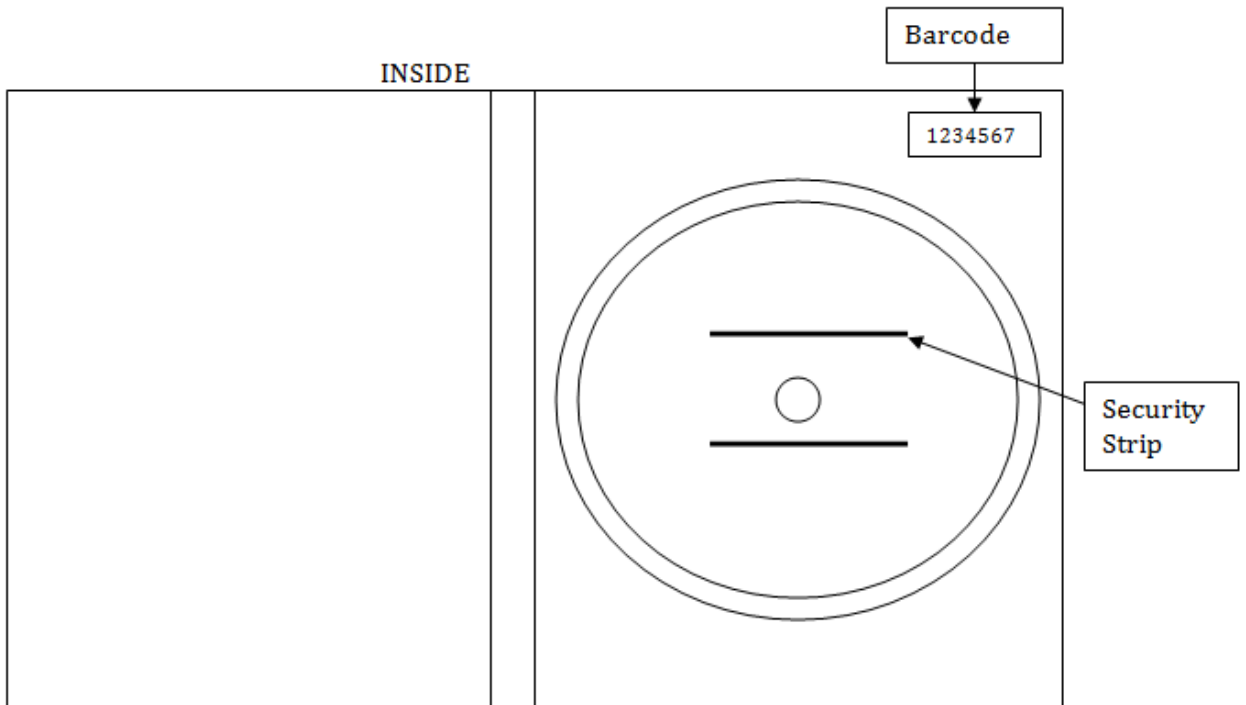

Physically Processing Books or Journals for Removal

Most items that are removed from the collection are given to AAUW for their book sales. Medical books are recycled because the information is outdated and not appropriate for sale. The librarian will indicate exceptions with a sticky note.

To prevent the item from ever coming back to us, all markings have to be removed.

- Remove/blackout spine label
- Remove barcode
- Remove/blackout reference dot
- Remove book pocket
- Black out library address stamps
- Stamp "WITHDRAWAL" on inside cover and title page

Any items that cannot be removed without creating physical damage can be blacked out with a marker or the front portion of the book pocket can be removed.

Desensitize all materials.

Put the item(s) aside for donation or recycling.



GREAT FALLS COLLEGE
MONTANA STATE UNIVERSITY

WEAVER LIBRARY

Shelving Materials

Preparing Items for Shelving

After an item has been checked in on the computer (see “Checking Items In and Out” section), it needs to be re-sensitized before it can go back on the shelf.

Items that need to be re-shelved are located in the gray bin next to the re-sensitizer or on the small cart next to the work/study desk.

Items that cannot be re-sensitized:

- Videocassettes
- Audiocassettes
- Books that have a 3 ½” floppy disk
- Basically, anything based on magnetism*

Items that can be re-sensitized:

- Books
- Books with CDs
- Journals/magazines
- Spiral bound books
- CDs/DVDs

If an item can be re-sensitized, place the re-sensitizer at the top of the item’s spine (or behind the book pocket of a spiral bound book or on back cover of CDs/DVDs). Press and hold the button as you slowly move the re-sensitizer down the entire length of the spine. One pass is sufficient, and you only re-sensitize in one direction. (Desensitizing is completed in the opposite direction at the Library Front Desk.)

The different Library items can be sorted by shelving areas:

CALL NUMBER as normally listed – STACKS

SPECIAL AREAS OF THE LIBRARY HAVE A SPECIAL CODE ON THE CALL NUMBER LABEL

- REF - reference
- VIDEOS - videos, cassettes, CD-ROMS, DVD, etc.
- NEW BOOKS – Yellow “NEW” tape under the call number
- OVERSIZE
- PERIODICALS
- OR ### - reserves (behind the front desk)
- AV-RACK – Audio Books

Shelving Materials

Shelving materials is an important responsibility. A book that is incorrectly shelved is a book that can be lost for a long period of time. **If you have a question or are uncertain about how to shelve a book, please ask for help.**

Call Numbers

This library uses **Library of Congress Classification** for call numbers. Call numbers are used to provide a unique identification numbers for each item; to allow books on similar subjects to be grouped together on the shelves; and to provide a method to locate books. Call numbers can be written horizontally or vertically. For example,

RT49.A45 2004 in the library catalog

RT
49
A45
2004 on the spine of the book

The **Library of Congress Classification** system uses combinations of letters and numbers.

HOW TO READ A CALL NUMBER

RT	Read the first line in alphabetical order : A, B, C, D, DA, DSL, R, RA, RT....
49	Read the second line as a whole number : 1, 2, 25, 48, 49, 50, 171, 283, 1078, 1079...
A45	The third line and <u>subsequent similar lines</u> are a combination of a letter and decimal numbers. Read the letter alphabetically . Read the number as a decimal : A.1, A.2, A.23, A.234, A.45, A.487, A.49, A.6, A.892, A.9
2004	The fourth line is the year of publication (2004). Read it in chronological order .
v.1	A fifth line can contain information for volume, copy, etc.

Location Information

The library has several special collections which are shelved separately from the regular collection. The call number will have an additional line to indicate in which collection the book can be found.

- Reference books have a prefix “REF” or “Ref” above the call number and are shelved in the Reference collection.
- Videos, guides/pamphlets for videos, cassettes and slides are shelved in the Media collection. Each will have a “Video”, “Cassette”, “AV Rack”, “DVD”, “CD”, “CD-Audio” or “Slides” at the bottom of the call number. Guides for individual videos have a “Video Guide” after the call number and are filed in the VIDEO area after the corresponding video.
- Curriculum books have a “CURR” following the call number and are filed in the Curriculum collection.
- Large books have “Oversize” on the bottom of the call number.



GREAT FALLS COLLEGE
MONTANA STATE UNIVERSITY

eLEARNING

Mission: GFCMSU eLearning promotes and supports a globally connected learning environment.

Vision: GFCMSU eLearning will continue to set ourselves apart as a leader in online education by providing quality, flexible learning opportunities.



GREAT FALLS COLLEGE
MONTANA STATE UNIVERSITY

eLEARNING

General Duties

eLearning – General Duties

Opening Procedure:

1. Turn on lights, computers, and printers. Check printer and load paper.
2. **Greet students** and faculty as they enter eLearning and ask them if they need assistance, making sure they sign into the kiosk with their Banner ID or name, select the reason they are in eLearning, and click Submit.
 - a. Have visitors mark the reason they are coming in:
 - i. Computer
 - ii. D2L Help
 - iii. Learn D2L – (Orientation)
 - iv. Password
 - v. Banner
 - vi. Student Email
 - vii. Printing

Visitors do not need to sign out at the kiosk when they leave, but they do need to log off the computer they were using.

3. Students should log onto the computers in eLearning with their Network account information if they know it. If not, log in using **distance1** as the username. (See information on setting up Network accounts.)
4. Since students may not know exactly why they are having difficulty with D2L or logging in and may not know the right questions to ask, it is important to be friendly, supportive, and ask a lot of questions narrowing down the reason they need assistance.
5. Student workers can handle routine questions about Banner Web, setting up their D2L / Student Email / Network account password and simple D2L help. Complex questions and problems should be referred to eLearning support staff. If you don't know the answer, ask a staff person for help.
6. Students who come in with homework help should be referred to the Learning Center.
7. Students who come in with advising questions should be referred to the Advising Center.
8. Students who come in with financial aid questions should be referred to the Financial Aid office, etc.

9. Keep an eye on students who may need assistance but are reluctant to ask for help.
10. Because students logged into the computers in eLearning using their personal network account, make sure students log out of their individual network accounts before leaving. The work study may have to ask students if they logged off the computer as they are leaving.

Customer Service

Customer service is very important at the College and the eLearning office strives to exceed expectations when dealing with students, faculty, staff and visitors. It is important to display a friendly demeanor and appear approachable and willing to help. New students to eLearning may be hesitant and wary of technology, so it is important to use tact and ask a lot of questions.

Telephone Etiquette

When answering the phone, state, "Good morning (or good afternoon), Great Falls College, eLearning, (*your name*) speaking. How may I help you?"

An **eLearning Phone Messages and Assists** pad is available for each worker. Record your phone message and assists that are not logged into the kiosk. These messages and assists will be entered into a tracking system that we refer to "Chico" and tallied each semester.

If you need to transfer a call, click on the "transfer" button and look up the person's number to whom you are transferring the call either on the phone list or the online directory. After you input the number, click the Connect button on work study phone. On Wayne's phone, you would click transfer, input the number, and click transfer again. When transferring a call, inform the caller that if the person on the end of the phone does not answer they should leave a message and they will return the call. To pick up a call directed to a staff member from the student worker phone, press the call pick up button.

When taking a message, make sure that you get the correct spelling of the caller's name, their phone number, and the reason for their call. Enter the date, time, and your initials on the message pad.

Each message or assist will be tracked and documented under the Action Taken section of the pad along with the time and date it is resolved. After appropriate action is taken, place a check mark by the Time/Date Resolved indicating the issue is resolved.

If you are instructed to call a list of names, put a small "lm" for "left message" by each number where you left a message, an "na" for "no answer," and wrong # if the number you

called is out of order or is a wrong number. If you are given a list of names to call, the eLearning staff will create a script for you. Generally, if you are calling a number in town, you will give the local number for the number they should call back. If you are calling a long-distance number, you will give the eLearning 800 number (**800-254-2815**) for them to call back.

It is important that you don't give out information that violates FERPA when leaving messages or when speaking on the phone.

When the **red light** is on the phone, this means there is a message. Press the **Message** button. When prompted for phone number, dial **4440#**. When prompted for password, enter . To listen to a message or repeat it, press "**2**", to go to the next message, press "**6**", and to delete the message, press "**76**".

The work study is not expected to answer phones for the individual members of eLearning. If an eLearning staff wants the work study to answer their phone, it is their responsibility to forward their phone to the work study phone, #4440, which is the main eLearning office phone extension.

Orientation to D2L

An eLearning student worker is expected to shadow the eLearning staff to learn how to assist students when they come into the office for D2L assistance. In addition, student workers will learn by helping with face-to-face orientations conducted by eLearning support staff and through role playing. Student workers are expected to become familiar with Banner Web, how to set up a D2L password, a Network account, student email, how to self-register for the D2L Student Resource Course, and become familiar with the information on the distance website. The FAQ link on the eLearning website contains a wealth of information for troubleshooting known problems and answers many questions students will ask. The work study is expected to be aware of the information contained in the FAQs and direct students to this portion of the eLearning website when necessary.

Have students log into Banner Web:

Explain that Banner Web is where students registered for classes, where official records are kept, and where mid-term and final grades are posted.

- Open a web browser and have students log into Banner Web by going to the College website, www.gfcmsu.edu, and clicking on Students, and then Banner Web [My Info]. Click “Enter Secure Area” and log in using their Banner ID and their Banner PIN.
- If students don’t know their Banner ID, they can enter their Social Security Number without the hyphens. If students don’t know their PIN, they can click on the “Forgot PIN” link and answer the security questions (providing they set these up when they registered.)
 - If students try too many times to log in, they may disable their Banner PIN. When this happens they will have to either go over to Student Central or have one of the eLearning staff reset their Banner PIN to their birthdate in the format of 01jan1990 if their birthday was January 1, 1990.
- Instruct the student to go to Personal Information, View IDs, and have them write down their Student ID (MSU ID), Net ID, and D2L ID on the backside of one of our eLearning business cards. We **highly** recommend students use their Net ID in place of their D2L ID because we are going toward a single sign-on system. Be aware that students’ D2L ID may have the following issues:
 - In some cases students will have a number after their last name
 - In some cases students may have a different spelling or a different name listed than the name they registered under in Banner.
 - If there is a discrepancy with the wrong last or misspelling, notify eLearning staff for further follow up with Admissions, the Registrar or Bozeman IT staff.
 - Bozeman Help Desk – Contact Information:
Tel: (406) 994-1777, Email: helpdesk@montana.edu

Have students create their D2L / Network / Student Email password:

- Go to password.gfcmu.edu
- Enter Last Name, MSU ID (Banner ID), and MyInfo PIN (Banner PIN) and click **Sign in**. Note: a student's social security number will not work in place of the Banner ID.
- To set a new password for D2L / Network / Student Email, follow the password rules:
 - 8 – 20 characters
 - Contains at least one letter and one digit
 - Contains at least one special character as listed
 - `~!@#\$\$%^&*()-_+=[]{}|\;":',<.>/?
 - Cannot contain their username or name
 - Remind students that this password will expire in 180 days.
- **Important!**
 - Have students mark **both** check boxes.
 - If students only have one check box (Net ID / Desire2Learn), have them contact the student-manned Help Desk in the atrium or by the bookstore or by calling 406-771-4433 or emailing helpdesk@gfcmu.edu. Notify eLearning staff of this discrepancy and ask for the correct spelling of their name and contact information. eLearning staff will follow up with IT, who may have to create their email account.
 - Without checking the box for the Network password, students will not be able to log onto campus computers using their unique username and password.
 - If a student's name is spelled wrong but is correct in Banner or is a previous name even though it is correct in Banner, they will need to either contact Admissions or the Registrar (who will contact the Bozeman IT department) or contact the Bozeman IT Help Desk in Bozeman directly at helpdesk@montana.edu or by calling 406-994-1777.
 - Have students enter a new password and re-enter before clicking **Submit**.

Have students activate their Student Email account:

- Go to www.gfcmu.edu and have students click on Students, and Student Email.
- Enter the Net ID and the D2L password and click **Login**.
- The student will need to acknowledge they have read and accept the terms of the email account
 - Point out that the NetID@msugf.edu shown on the top right of the window is **NOT** their student email address. This is an identifier only.

- Have students click **Compose** to open a new email window and have them verify their student email address.
- Important: point out that their email address should be in the format of **firstname.lastname@my.msugf.edu** (at some point this will be @my.gfcmsu.edu)
- Explain that the Student Email account is where official college email will be sent but they can forward this email to their personal email account if they prefer.
 - Point out that the Student Email account is separate from D2L email.
 - If students need a refresher on Student Email and Network Access, students may review the video on Student Email and Network Access in the D2L Student Resource Course.

Explain Network Accounts:

- Students should be able to log onto any computer on campus using their D2L login information, using firstname.lastname and the password they just created.
- When students log on to their Network account, any files they save are saved on the network.
- It is important for each student to log out of their account when leaving the area.
- It is the student worker's responsibility to monitor the computers to make sure students log out of their accounts before another student sits down at that computer.
- Any problems with the Network accounts should be referred to the Help Desk and the IT department.
- The student can connect to MSUGF student network (this name may change to GFCMSU), open a web browser, which will redirect them to a sign-in page where they should enter their firstname.lastname and their network password.
- Students can also access the College's wireless network by using the guest network. However, this network provides limited functionality.

D2L Online Orientation:

- New students can register for an online orientation through Banner which consists of a set of videos and replicates the 4-hour face-to-face New Student Orientation offered at the beginning of the semester.
- However, students may also self-register for the D2L Student Resource Course, which now contains the same videos as the New Student Orientation.
- To self-register for this practice class, students should log into D2L, click on the Self-Registration link on the blue navigation bar on the top right part of their screen, click on D2L Student Resource Course, and click Register, Submit, Finish and Done. The D2L Student Resource Course should now show up in the student's list of courses under "Select a Course" at the top of the screen.

- The D2L Student Resource course is a practice D2L course and is used as an online orientation to D2L or as a refresher on the D2L tools. Have the student click on the course name to log into the course.
- Students should click on the Contents link and watch the videos in the modules that they wish to view. These are short videos, approximately 3 minutes long.
 - Depending on the web browser the student is using, they may have a security question pop up. If students are using Internet Explorer, they may need to click “Show All” to see the video because it is being blocked by the browser.
- Additional videos focus on various D2L tools. Recommend that students watch each video in order and complete the practice steps as instructed.
- Students will practice with the following:
 - Posting an email using the classlist
 - Posting to a discussion message
 - Opening and replying to a discussion posting
 - Completing a practice homework assignment and submitting it through the dropbox.
 - Completing a practice quiz
 - Completing a D2L survey

Getting Help and Knowing Where to Find IT

- eLearning Website: elearning.msugf.edu
 - Students will find a “Get Started Here” button
 - Welcome letter
 - Instructions to create D2L password and how to log into D2L
 - Link to introductory videos on Banner Web, Logging into D2L, Resources
 - Quick Links
 - Digital D2L eLearning Guide
 - D2L Login Info
 - Testing Center
 - Online Chat Hours and Chat Button
 - Atomic Learning (video tutorials on software)
 - Other Student Resources
 - Netiquette
 - Strategies for Success
 - Tech Requirements
 - Tutorials
 - Contact Information and Office Hours
 - eLearning staff will post notices to students on the D2L login page
 - D2L Help Request Form
 - System Check link
 - Video Tutorials
 - Online chat with eLearning Staff and live D2L support and hours
 - Forgot password link

- D2L Login
- FAQs
 - An extensive list of frequently asked questions and the answers
 - Frequently asked questions are broken down into sections
 - Prospective Student Questions
 - Current Student Questions
 - D2L Specific Questions
 - These FAQs are updated frequently so familiarize yourself with these
- Familiarize yourself with additional links on this page:
 - Library
 - Information on how to access library resources
 - Bookstore
 - Information on how to order books and book buy back information
 - Directories
 - Contact information for faculty, staff, and departments on campus
 - Contact
 - Listing of offices on campus with their email and phone information
 - Fax numbers
 - Links to Facebook – Social Media Contacts
 - Colleges address and phone and main switchboard
 - Online Programs
 - A list of our online programs
 - Student Resources
 - Faculty Resources
 - Why GFCMSU Online?
 - Current Students
 - This is where you would find forms online students would need
 - Become a Student
 - This is where you will find the Tuition and Fee information
- Answering questions for students or parents of students
 - Always refer to the **catalog** or the **college's policy manual** for information in response to questions that may be asked while you are assisting students
 - If you do not feel comfortable with the question, refer the question to eLearning staff or to the appropriate department
 - For instance, because of the complexity of financial aid, refer those types of questions to the Financial Aid Department and do not attempt to answer except for very general questions

Computer Use in eLearning

Computers in eLearning are for students who are having technical problems, learning D2L, or need a little assistance with technology. Students who need to do homework or general printing of multiple course handouts should use the computer lab in the Library.

There are two printers in eLearning. The large Dell printer is a color printer, and the eLearning staff primarily print to this printer. Students print to the smaller black and white HP Laser Jet printer. The student worker's computer will print to either printer.

- Become familiar with the student printer so you are prepared to change the cartridge, load paper, and demonstrate how to insert paper to print double sided manually and how to print PowerPoint handouts instead of full-size PowerPoint slides.

While students are learning D2L, they may print off their syllabus or class schedule in eLearning as well as initial papers to get them started. The same policy for students supplying their own paper applies in eLearning. If students do not have paper with them, they can purchase paper in the Library or in the Bookstore.

Paper that is left in the printer as unclaimed and barely printed on can be saved for those students who need scratch paper or want to print on the back side. Occasionally, students will donate a stack of paper for other students to use. Scratch paper is stored under the black and white printer for student use.

Students who need to print in color can do so in the Library for \$.25 a sheet. Students who do not bring their own paper are charged \$.10 a sheet in the Library, so we recommend students purchase their own paper from the Bookstore, which is sold in small increments.

Room A124 (also known as the Fishbowl or Sandbox) is a model flipped classroom which is also used for training faculty during the semester and students during orientations. Faculty and students can reserve A124 when it is available. Karen Vosen schedules A124 using the EMS system and Beth Cooper is the backup for scheduling A124. After hours, the Library will schedule A124 for evening hours on a paper schedule.

- Students scheduled in A124 for their class should enter and exit through the Library. After students leave, the work study should check the room to make sure everything is in order and put away.

If there is a problem with any computer or printer in eLearning, be sure to notify the eLearning staff immediately so we can get the problem resolved.

- If students need specific software for an online class, refer students to Wayne Breau, the Instructional Technology Specialist.
- Students who need to record a video or an audacity file for an online class can use the computers in the eLearning office (or in A124 if available) and they may require assistance.

Routine Duties

Complete given tasks on a daily basis. Tasks may be given by any member of the eLearning team. If given a task involving computer software, save files on a jump drive, also known as “the Man,” because the jump drive is on a white Intel robot figure. At the end of the shift, “the Man” is given to one of the eLearning staff for safekeeping.

On a daily basis:

- Greet students and make sure they sign in at the kiosk.
- Check to make sure students log off when they leave the office.
- After eleven o'clock, check the mail in the in the hall by the Print shop. The eLearning mailbox is #54 and the key is on “the Man.”

On Fridays, dust computers and shelves and general housekeeping as needed, i.e. dumping pencil sharpener and hole puncher; sanitizing keyboards, mice, and phones, etc.

At the beginning of the semester work study tasks include the following:

- Update the digital map of Montana which reflects the location of the online students for that semester. eLearning staff will supply a list of students from the Registrar's office after the fifteenth day of the semester.
- Assist with D2L orientations and training as needed.

Update the phone list when needed.

Closing the eLearning Office

- Turn computers off.
- Shut off lights.
- Lock the door.



GREAT FALLS COLLEGE
MONTANA STATE UNIVERSITY

eLEARNING

Data Tracking

CHICO (Data Tracking) Instructions

CHICO is the data tracking system used by eLearning. All traffic in the eLearning office is tracked through CHICO. When a student or faculty comes in simply ask them to sign in at the iPad kiosk. If, for some reason, they do not sign in, the work study will either enter their name for them or enter them as Jane or John Doe and the reason they were in the office.

The following are recorded in CHICO at the kiosk:

- Computer
- D2L Help
- Orientation
- Password
- Banner
- Student Email
- Printing
- Other

To enter data manually in CHICO:

Open up the Firefox browser. On the bookmarks menu bar click CHICO or go to elearningkiosk.gfcmsu.edu/admin.php.

The login information is:

Username: Password:

Note:

All interactions with eLearning are documented in the “CHICO” Data Tracking System, including phone calls, chat incidents, walk-ins, emails, and individuals attending a D2L orientation, etc. are entered into CHICO. This data is compiled for an annual report by the eLearning staff.

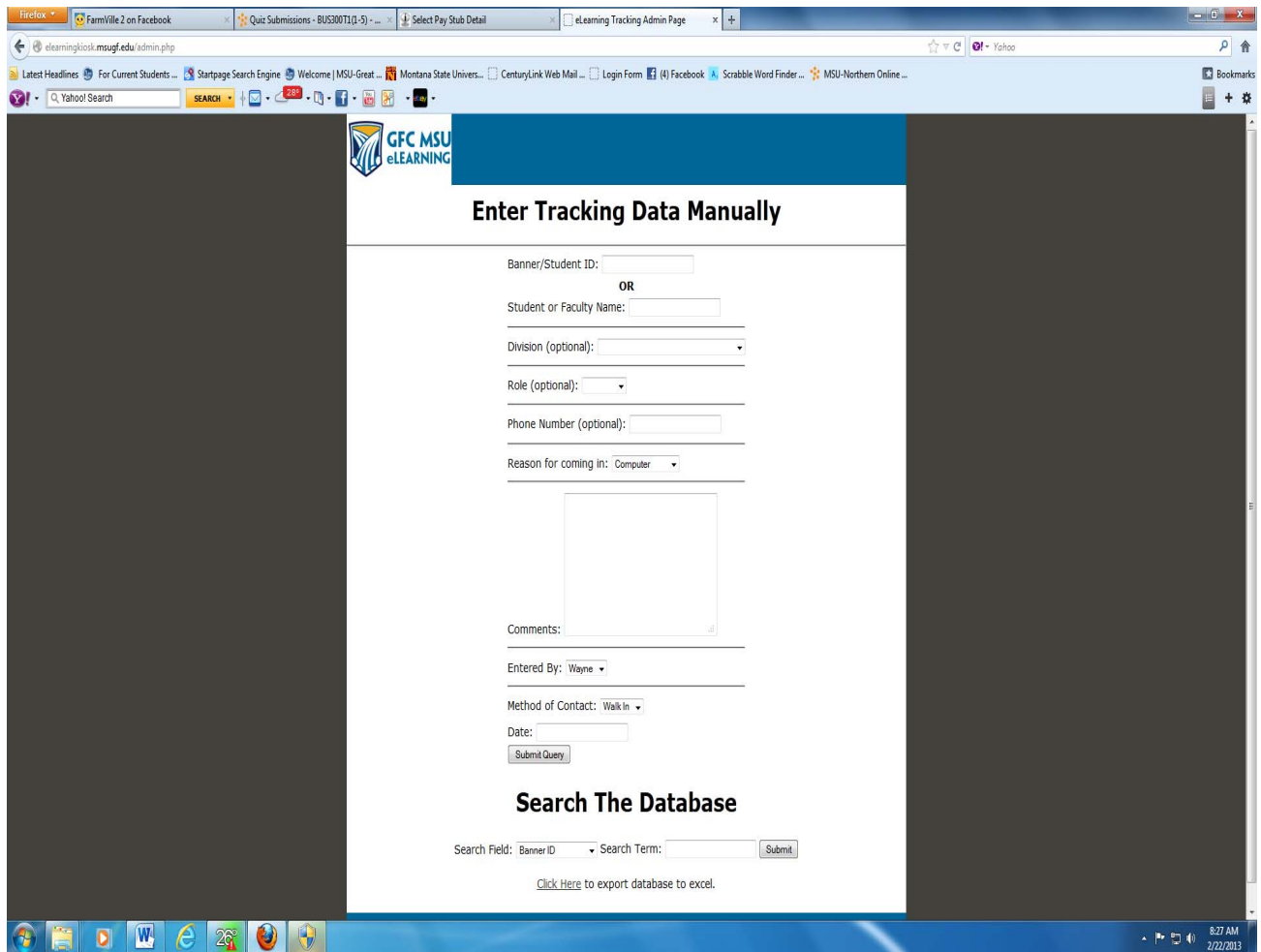

Steps to enter tracking data manually in CHICO:

- Either fill out Banner/Student ID or Student or Faculty Name. If unknown simply use Jane or John Doe. Never enter both the Banner/Student ID and the name in the same entry.
- Mark whether they are a student or faculty.
- Faculty should mark which division they are with in the Division line.
- When entering a call or message, fill in the Phone Number line.
- Mark the reason for coming; this applies to phone calls as well.
- Enter “Other” in the “Entered By” field if your name isn’t listed.
- Mark the correct Method of Contact.
- Click on the Date field and click on the day that the contact was made and if it is the current time click “Now” on the lower left hand corner.
- Click Submit Query to complete the entry.



GREAT FALLS COLLEGE
MONTANA STATE UNIVERSITY

eLEARNING

Bulk Mailing

Bulk mailing for post card instructions

Upon getting the unduplicated list of student addresses from the eLearning staff, save the list by selecting “save as” a new file and click on the Data tab and under sort and filter, click the sort button sort it by zip code, this will give you an idea of how many are for Great Falls and how many go out of town.

1. Start a Word document and click on the **Mailings** tab.
2. Click **Start Mail Merge**, and click **Step by Step Mail Merge Wizard**.
3. On the right hand side click the button for **Labels** and click **Next** on the bottom.
4. On step two just click **label options** and if this shows up click ok for MACTac Starliner Labels or Avery U.S. Letter for label vendors and click to find SR6600 or 5160 Easy Peel Address Labels and click **OK** on the mail merge warning .

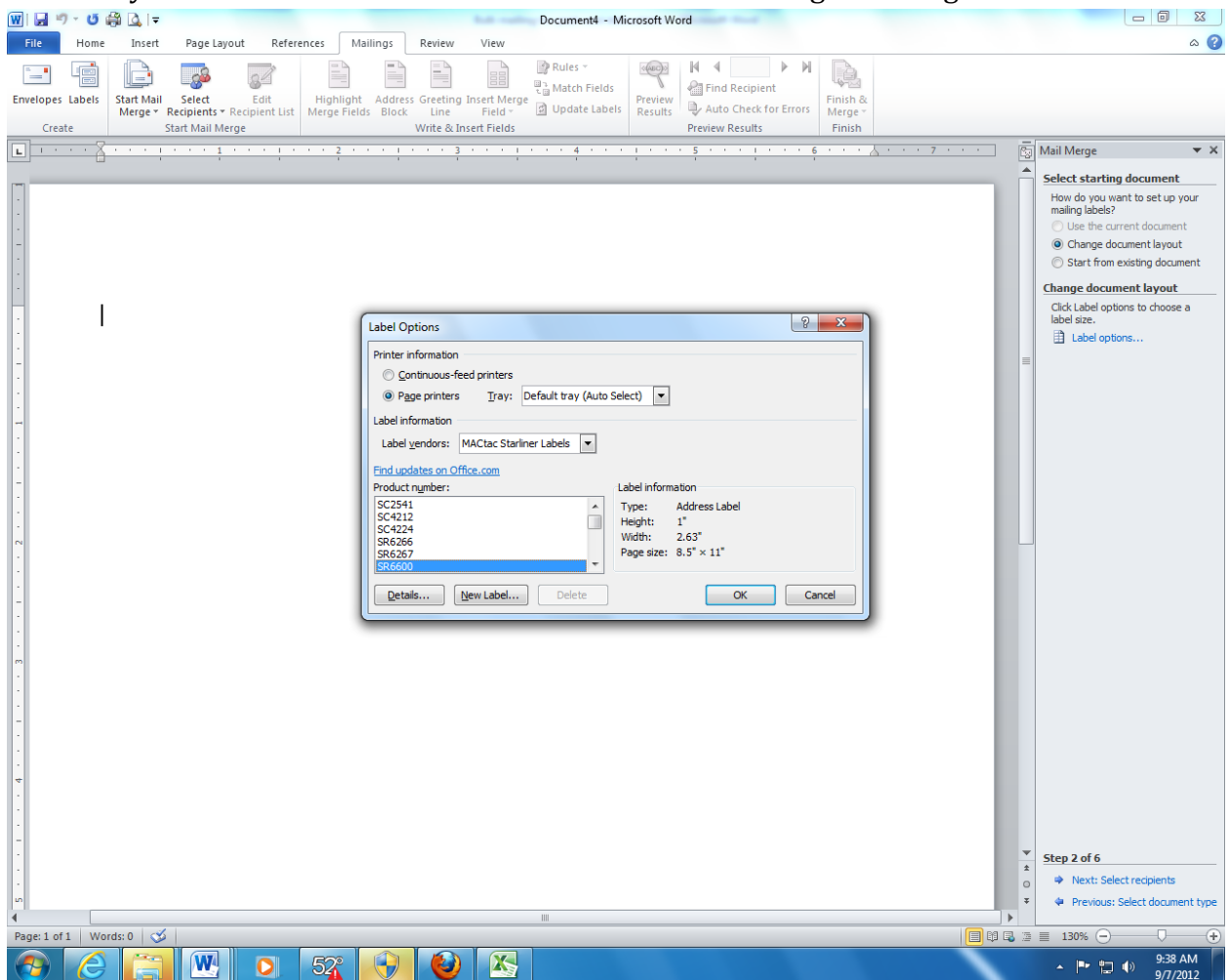

5. Under Use an existing list on step 3 click **Browse** and locate the spreadsheet for the new file of unduplicated students and double click the filename.
6. Sort by Zip Code and click **OK**.

7. On step three, Click **Next** to arrange your labels, click **Address block** and if the name shows up click **OK**.
8. Click the home tab, and on the spacing icon click to remove space after paragraph.
9. Click **Enter** to move to the next line and click **More items** on the left. Click on the **Street field** and click **Insert** and click **Close**.
10. Click **Right** after the entry and click **Enter** to move to the next line.
11. Click **More items** and click the field for **City**, click **Insert** and click **Close**. Insert a comma and a space and click **More items**.
12. Click on the **State** field and click **Insert** and **Close**.
13. Press on the space bar to insert a space between the state and zip code field. Click the **More items** and click **Zip** and **Insert** and **Close**.
14. Next click the **Update all** labels button to update all the labels on step 4 of 6. Your page should look like the following:

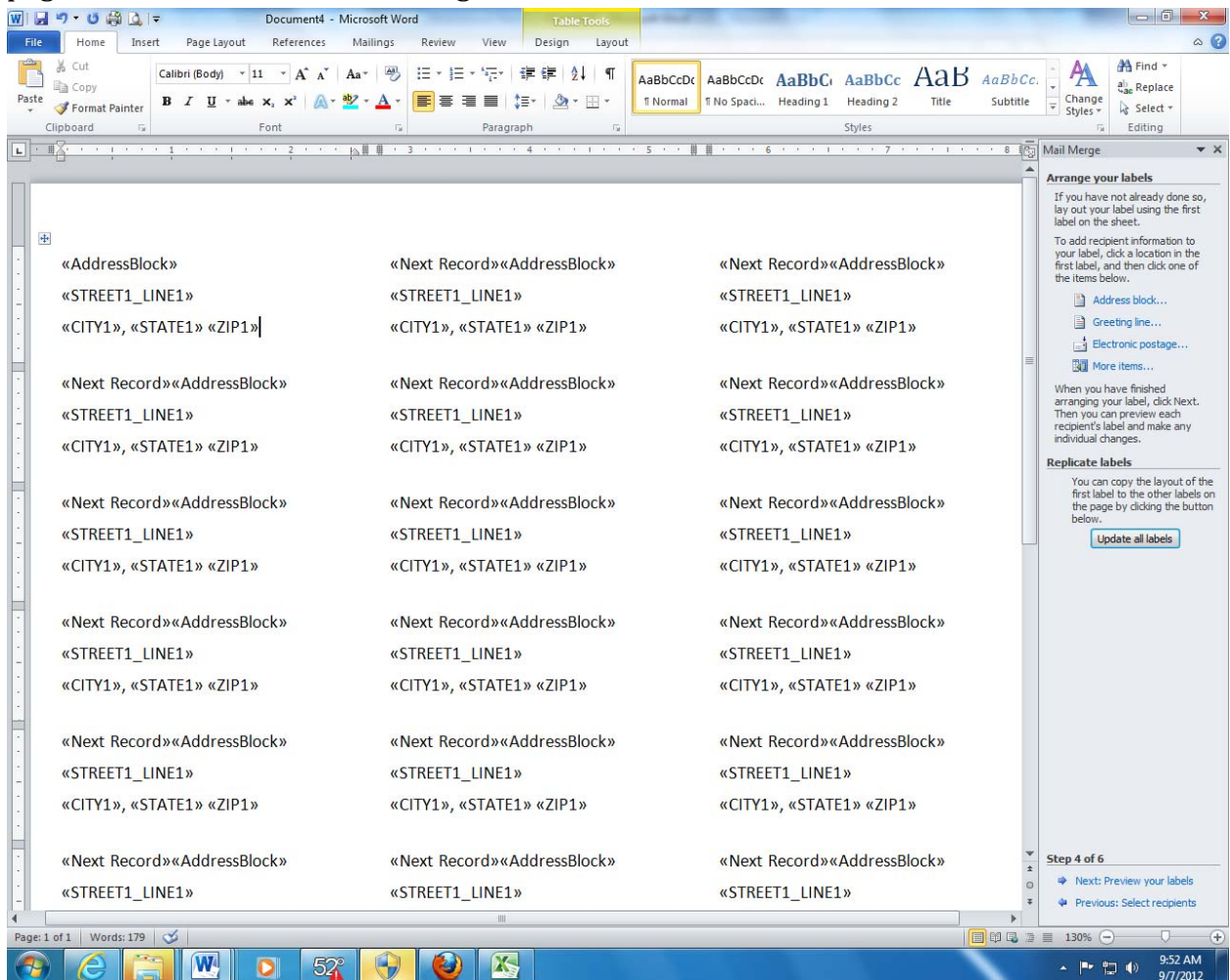

15. If you are using MACTac Starliner Labels, click **Page Layout**, click **Margins**, click **Custom Margins** and change top Margin to **.75** and click **Ok**. Click **Fix** and Click **OK**

again. This allows the labels to be printed correctly on the label paper. Note: If you selected Avery 5160 labels, you can skip this step.

16. Click **Next** to preview your labels.
17. Click **Home** and the spacing to make sure the addresses are complete.
18. Click **Next** to complete the merge.
19. Put label paper in the printer label side up and click **Print** on the right hand side and **Ok** to print the labels.
20. Affix labels to the postcards separating by zip codes working your way horizontally across the page of labels. Count each group of post cards per zip code and separate. For instance count all the pieces of mail with a five-digit zip code 59401 and indicate the count on a sticky note, next do the same for 59403, 59404, 59405, all other 594__ 's and then count all the out of state and keep in a separate pile.

Bulk Mail.pdf - Adobe Reader
File Edit View Window Help

Bulk Mail Check List



- First email or contact Deb Gunter :
E-mail: dgunter@msugf.edu
Phone: 4392
Office: G20
to verify that there are funds on deposit for bulk mailings.
Usually one week prior
- Print Off Current Form located on the commons Drive:
[K:\Bulk Mail Forms March2010](#)
- Prepare Bulk Mail as the forms instructions indicate.
- After returning from the Bulk Mail Center make two copies of the final form . It should include the cost of mailing and the department it is charged to.
- Turn in copy to Deb Gunter

Click on Sign to add text and place signature on a PDF File.

11:11 AM
9/10/2012

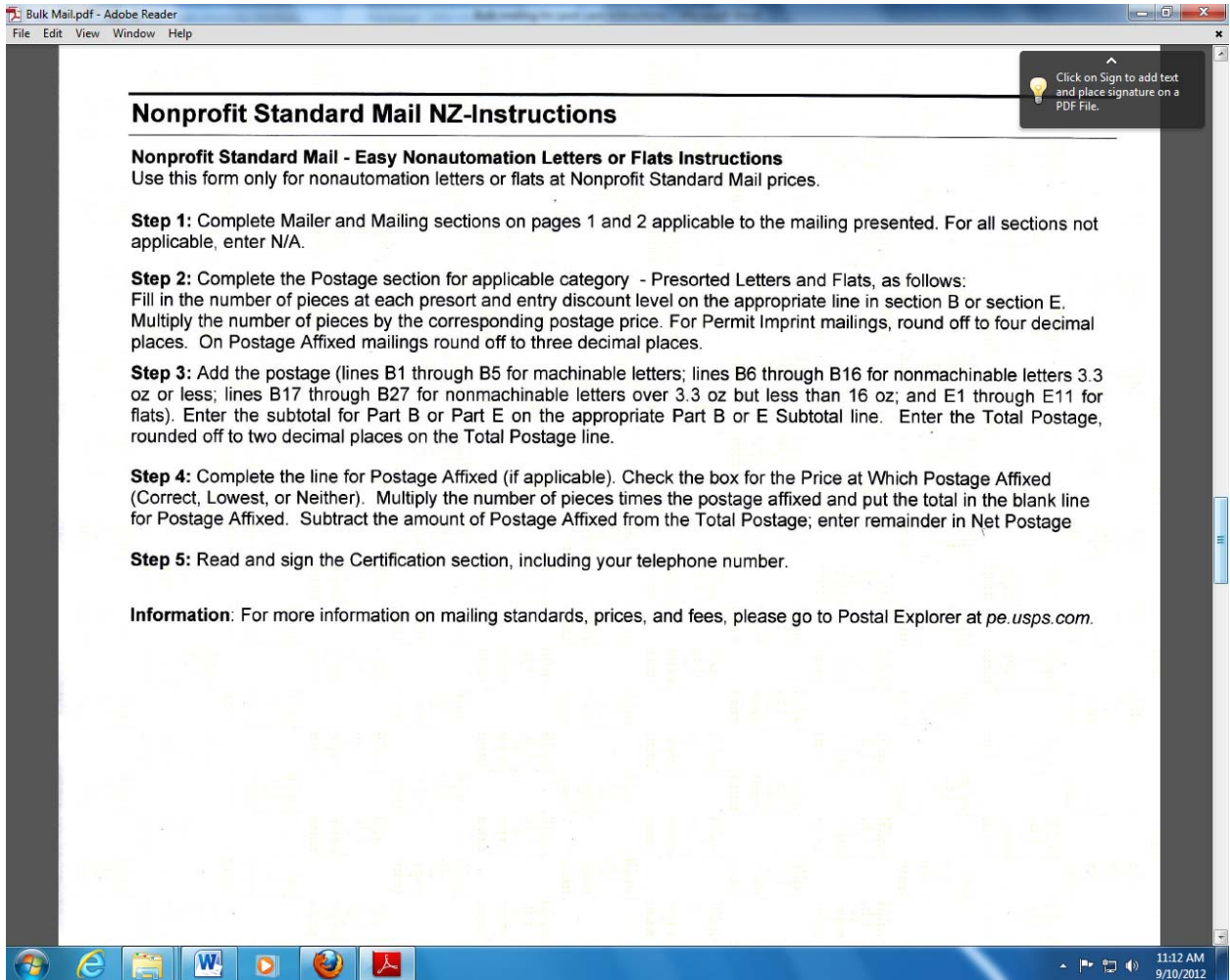

21. The following forms need to be filled out:

United States Postal Service
Postage Statement—Nonprofit Standard Mail
Easy-Nonautomation Letters or Flats

This form may be used only for a single nonautomation price mailing of identical-weight pieces. Use PS Form 3602-N for all other Nonprofit Standard Mail mailings. Checklists and other tools for mailers are available on the Postal Explorer website at pe.usps.com.

Mailer
 Permit Holders Name and Address and Email Address, If Any
 Great Falls College Montana State University
 2100 16th Avenue South
 Great Falls, Montana 59405
 Telephone: 406-771-4440
 USPS Nonprofit Auth. No. 625160
 CRID

Mailing

Post Office of Mailing Great Falls	Mailer's Mailing Date 8-23-12	Permit No. 212	Federal Agency Cost Code	Statement Seq. No.	No. & Type of Containers
Type of Postage <input type="checkbox"/> Permit Imprint <input type="checkbox"/> Precanceled Stamps <input type="checkbox"/> Metered	Weight of a Single Piece 0 _____ pound			Processing Category <input checked="" type="checkbox"/> Letters <input type="checkbox"/> Flats	Sacks _____ Trays <input checked="" type="checkbox"/> Pallets _____
Move Update Method: <input type="checkbox"/> Ancillary Service Endorsement <input type="checkbox"/> FAST/Forward <input type="checkbox"/> OneCode ACS <input type="checkbox"/> NCOA/Link <input type="checkbox"/> ACS <input type="checkbox"/> Alternative Method <input type="checkbox"/> Multiple <input type="checkbox"/> n/a Alternative Address Format				Total Pieces 807	Total Weight

Mailpiece is a product sample
 Letter-size or flat mailpiece contains DVD/CD or other disk
Total Postage (Add parts Totals) \$ 91.19
 Price at Which Postage Affixed (Check one) Complete if the mailing includes pieces bearing metered or precanceled stamps.
 Correct Lowest Neither _____ pcs. x \$ _____ = **Postage Affixed**

Postage

Permit # _____ **Net Postage Due (Subtract postage affixed from total postage)**

Additional Postage Payment (State reason)

For postage affixed add additional payment to net postage due; for permit imprint add additional payment to total postage. **Total Adjusted Postage Affixed**

Postmaster: Report Total Postage in (Permit imprint only) **AIC 125 Total Adjusted Postage Permit Imprint**

Certification

The mailer's signature certifies that: (1) the mailing complies with DMM 703; (2) the income derived from the sale of any products or services advertised in the mailing is not subject to the Unrelated Business Income Tax (UBIT) and any products and services advertised are substantially related to the nonprofit organization's authorized purpose within the meaning of 39 U.S.C. 3626(j)(1)(d)(ii)(I) and 26 U.S.C. 513(A); (3) the mailing if made by a voting registration official is required or authorized under the National Voter Registration Act of 1993; and (4) it will agree to pay, subject to appeal, any revenue deficiencies assessed on this mailing. If an agent signs this form, the agent certifies that he or she is authorized to sign on behalf of the mailer, and that the mailer is bound by the certification and agrees to pay any deficiencies. In addition, agents may be liable for any deficiencies resulting from matters within their responsibility, knowledge, or control. The mailer hereby certifies that all information furnished on this form is accurate, truthful and complete; that the mail and supporting documentation comply with all postal standards and that the mailing qualifies for the prices and fees claimed; and that the mailing does not contain any matter prohibited by law or postal regulation. I understand that anyone who furnishes false or misleading information on this form or who omits information requested on this form may be subject to criminal and/or civil penalties, including fines and imprisonment.

Privacy Notice: For information regarding our Privacy Policy visit www.usps.com

Signature of Mailer or Agent _____ Printed Name of Mailer or Agent Signing Form _____ Telephone _____

USPS Use Only
 To be completed in non-Postal/One! sites

Weight of a Single Piece _____ pound	Are postage figures at left adjusted from mailer's entries? If yes, reason: <input type="checkbox"/> Yes <input type="checkbox"/> No
Total Pieces _____ Total Weight _____	
Total Postage _____	Round Stamp (Required) Payment Date _____
Presort Verification Performed? (If required) <input type="checkbox"/> Yes <input type="checkbox"/> No (Check one)	Date Mailer Notified _____ Contact _____
I CERTIFY that this mailing has been inspected for each item below if required: (1) eligibility for postage prices claimed; (2) proper preparation (and presort where required); (3) proper completion of postage statement; (4) payment of annual fee (if required); and (5) sufficient funds on deposit (if required)	By (Initials) _____ Time _____ AM _____ PM
USPS Employee's Signature _____	Print USPS Employee's Name _____

USPS Use Only
 To be completed in non-Postal/One! sites

Bulk Mail.pdf - Adobe Reader
 File Edit View Window Help
 1 / 6 85% Tools Sign Comment

Nonprofit Standard Mail Postage (cont.)

Part B Letters-3.3 oz. (0.2063 lb.) or less						Part E Flats-3.3 oz. (0.2063 lb.) or less					
Machinable Entry	Price Category	Price	No. of Pieces	Total Postage		Entry	Price Category	Price	No. of Pieces	Total Postage	
B1	None AADC	\$0.156				E1	None 5-Digit	\$0.251			
B2	None Mixed AADC	0.172				E2	None 3-Digit	0.332			
B3	DNDC AADC	0.123				E3	None ADC	0.380			
B4	DNDC Mixed AADC	0.139				E4	None Mixed ADC	0.413			
B5	DSCF AADC	0.113	807	91.19		E5	DNDC 5-Digit	0.218			
						E6	DNDC 3-Digit	0.299			
						E7	DNDC ADC	0.347			
						E8	DNDC Mixed ADC	0.380			
						E9	DSCF 5-Digit	0.208			
						E10	DSCF 3-Digit	0.289			
						E11	DSCF ADC	0.337			
						Part E Total (add lines E1-E11) <input type="text"/>					

Nonmachinable - 3.3 oz. (0.2063 lb.) or less

Entry	Price Category	Price	No. of Pieces	Total Postage
B6	None 5-Digit	\$0.280		
B7	None 3-Digit	0.373		
B8	None ADC	0.412		
B9	None Mixed ADC	0.509		
B10	DNDC 5-Digit	0.247		
B11	DNDC 3-Digit	0.340		
B12	DNDC ADC	0.379		
B13	DNDC Mixed ADC	0.476		
B14	DSCF 5-Digit	0.237		
B15	DSCF 3-Digit	0.330		
B16	DSCF ADC	0.369		

Nonmachinable Letters Over 3.3 oz. but less than 16 oz.

Entry	Price Category	Piece Price	Or Amount Affixed	No. of Pieces	Pieces Subtotal	Pound Price	Pounds	Pounds Subtotal	Total Postage
B17	None 5-Digit	\$0.119				0.639			
B18	None 3-Digit	0.200				0.639			
B19	None ADC	0.248				0.639			
B20	None Mixed ADC	0.281				0.639			
B21	DNDC 5-Digit	0.119				0.478			
B22	DNDC 3-Digit	0.200				0.478			
B23	DNDC ADC	0.248				0.478			
B24	DNDC Mixed ADC	0.281				0.478			
B25	DSCF 5-Digit	0.119				0.430			
B26	DSCF 3-Digit	0.200				0.430			
B27	DSCF ADC	0.248				0.430			

For affixed postage mailings as described in DMM 243, compute and enter the price for each piece in the Amount Affixed column, multiply by No. of Pieces and total in the Total column.

Part B Total (add lines B1-B27)

Windows Taskbar: 11:15 AM 9/10/2012

eLearning

MAILER Great Falls College-MSU PERMIT # 212 DATE 8-23-12

MAILING CONTENT FORM		
REQUIRED ON FIRST CLASS OR STANDARD PRESORT MAILING		
ZIP CODES	TOTAL	
DSCF 59401	150	
DSCF 59403	12	
DSCF 59404	246	
DSCF 59405	337	
DSCF 59406	4	
DSCF 594	58	
All 594's includes other city or town that has 3 digit 594 such as Conrad, Vilm etc.		TOTAL <u>807</u>
NONE 590		
NONE 591		
NONE 592		
NONE 593		
NONE 595		
NONE 596		
NONE 597		
NONE 598		
NONE 599		
Out of State		TOTAL <u> </u>

ALL DSCF STANDARD MAIL MUST BE ENTERED ON **D5 AADC RATE**

EACH NONE 5 DIGIT, 3 DIGIT, & AADC ZIP CODE MUST HAVE 150 PCS TO CLAIM THE **AADC RATE (D1)** AND IF LESS THAN 150 PCS MUST CLAIM THE **MIXED AADC RATE (D2)**

ANNUAL PRESORT MAILING FEE \$185.00

MAILINGS OF 200 OR MORE ADDRESSED PIECES, SORTED ARE REQUIRED FOR STD MAILING. EACH PIECE MUST INCLUDE A COMPLETE DELIVERY ADDRESS WITH CORRECT ZIP CODE OR ZIP+ 4 CODE.

BUNDLING NOT PERMITTED EXCEPT FOR MAILINGS OF CARD SIZE PIECES AND FOR PIECES PLACED IN LESS THAN FULL 3 DIGIT ORIGIN OR MIXED AADC TRAY.

TRAYING SEQUENCE FOR STANDARD & FIRST CLASS MAIL:

STANDARD: 3-Digit Origin/Entry: TRAYS: Optional, trays may be prepared for each origin 3-digit tray; on less than full tray permitted. AADC: Trays: Required, 150-piece minimum to the same AADC; one less-than-full/overflow tray permitted. Mixed AADC: Trays: Required for any remaining pieces placed in a mixed AADC tray, one less-than-full/overflow tray permitted. Rate is MACHINABLE AADC or 3 digit Origin/Entry & AADC and Machinable Mixed AADC for Mixed AADC.

FIRST CLASS: 3-Digit Origin/Entry: Trays: Required, trays must be prepared for any pieces to each origin 3-digit Zip Code; one less-than-full tray permitted for each origin Zip Code. AADC: Trays: Required, full trays for pieces to same AADC; pieces grouped by 3-digit Zip code; one less-than-full tray not permitted. MIXED AADC: Trays: Required for any remaining pieces placed in mixed AADC trays; pieces grouped by AADC; only one less-than-full tray permitted. RATE IS PRESORTED ON ALL ENTRY 500 pieces required to claim presorted rate for First Class mail letters or cards.

DEFINITION OF A "BOOKLET" - Booklet must have a bound edge. Sheets that are fastened with at least two staples in the manufacturing fold (Saddle stitched), perfectly bound, prepared glued, or joined together by another binding method that produces an end where pages are attached together are considered BOOKLETS. Booklets are open on three sides before sealing. To get machinable rate, Booklet must be sealed with 1 1/2-inch tab, two on the leading edge and one on the trailing edge. Not following the instruction will result in paying the nonmachinable rate.

ONLY THE POSTAGE STATEMENT DATE (JANUARY 2010) MUST BE USED, COMPLETELY FILLED IN AND SIGNED BY THE MAILER. CHECK OR MONEY ORDER IS THE ONLY ACCEPTABLE PAYMENT FOR BULK MAILING (NO CASHING CREDIT CARD PLEASE). IF YOU ARE TO PAY BY CHECK PLEASE MAKE SURE BRING THE CHECK PRIOR TO 4:30 PM IN ORDER TO AVOID NEGATIVE BALANCE ON YOUR PERMIT DEPOSIT ACCOUNT. YOU CAN ALSO MAKE YOUR DEPOSIT AT THE MAIN POST OFFICE DURING THEIR OPERATING HOURS. ENSURE TO MENTION YOUR PERMIT NUMBER.

A First Class Mail the "LETTER" processing category depends on the physical dimensions of the mailpiece without regard to placement of the address. Once a piece is determined to be letter-size, the placement of the address then determines whether the mailpiece is mailable or non-machinable letter. First, the mailpiece is letter-size if the longest dimension is not greater than 11 1/2", the shorter dimension is not greater than 6 1/8", the piece is not thicker than 1/4", and it weigh 2.5 ounces or less. Next, if the piece is within letter dimensions, determine if it is machinable. Nonmachinable or nonmachinable according to the length and height as determined by the address placement. If the address is parallel to the shorter edge of the piece, it is either nonmailable or nonmachinable. If the letter is nonmachinable, the 20 cents nonmachinable surcharge applies.

TOTAL PIECES 807
Put this total in the Postage Statement (Front)

For questions or need help regarding above Mailing Form, please call the BMEU Bulk Mail Technician at 791-2566

They can be found on the common drive under Bulk Mail. You may need to visit the bulk mail web site for latest issues of these.

WEAVER LIBRARY PROCEDURE MANUAL

Reports

Overview

Monthly Reports

Circulation Statistics

Electronic Database Statistics

Collection Development

Items Added

Gate Count Activity (Average Daily Count)

Overdues

Schedule of Billing Reports

Overdues (Weekly)

Fines (Monthly)

Lost Items (End of Semester)

Periodic Reports

Collection Development

Items Removed

Purge "Required Field"

Patron Fine Reports (Unpaid, but not monthly)

Quarterly Reports

Circulation

Interlibrary Loans

Annual Reports

Circulation

Interlibrary Loan Summary Report

Inventory and Collection Valuation

SIRSI Report Scheduling Basics

Year End Summary

REPORTS

The “Reports” section has three parts: (1) intro, (2) “SIRSI Report Scheduling Basics. . .” from a workshop hosted by Bob Tetro, Bozeman (3) report instructions with examples.

Reports will be only basically covered in this section. It is by no means a complete instruction on all examples. If there is a new type of report that you want to create, it is acceptable to make several runs to obtain the results that you desire. Keep the report as simple as possible. Run 4 or 5 simple reports instead of one large report. Bozeman requests that one report is run at a time and wait for the results instead of running a lot of reports in sequence at one time.

Be careful because some type of reports can affect the user or item records. An example of a situation with automatic updates is the “GF Weekly Overdue Notices”. There are also other reports with update effects such as item, serial, etc. Certain reports are not available locally but only for administrative purposes.

The SIRSI help section for reports is excellent for locating information about reports. Questions about reports should be first directed to the Library Staff person in charge of reports. If you have any questions on the effects of a report that you want to run, contact Bob Tetro in Bozeman. Contact Erik Guss or Ben Hager in Bozeman if there is any administrative concerns or need to have the report adjusted to a useable form (such as a report only accept Dewey and needs to accept LC).

Any report that uses the word “count” in its description gathers data for only current users. When there is a drop-down selection option, be sure to use the selection through the drop down instead of typing in the desired criteria such as a date range selection (this applies for any SIRSI selection whether in Reports, Title, Serials, etc).

If the title or item reports that you run include unwanted extra information, set the criteria for specific bib lines and change the Title, Call Number, and Copy information for the desired results. Reports can be brief and contain only the information that is desired!

There are certain basic settings that need to be set to view reports correctly.

There are certain steps described in “SIRSI Report Scheduling Basics . . .” that are useful only as description but apply more to Bozeman procedure than what is used locally.

Try to delete finished reports in a timely basis. Bozeman will remove reports that are two months old but will send notices before deleting old reports.

MONTHLY REPORTS: Circulation Statistics

The Librarian utilizes Monthly Circulation Reports for statistical purposes.
The following reports are run on a monthly basis:

1. Circulation Stacks, Periodical, Video

“Schedule New Reports”

“GF Charge Statistics2”

“Schedule”

“Selection Criteria” tab

Scroll to “Transaction selection”

“Transaction date range” – Click side button to select full month (1/1/2005 thru 1/31/2005)

“Schedule”

“OK”

“Close”

Wait for the report to run - Click “Finished Reports” to view report

2. Reserves

“Schedule New Reports”

“GF Reserve Statistics”

“Schedule”

“Selection Criteria”

“Transaction selection”

“Transaction date Range” – Click side button to select full month (1/1/2005 thru 1/31/2005)

“Schedule”

“OK”

“Close”

Wait for the report to run - Click “Finished Reports” to view report

3. Renewals

“Schedule New Reports”

“GF Renew Statistics”

“Schedule”

“Selection Criteria” tab

Scroll down to the “Transaction selection” part of the page

Leave all entries alone except for “Transaction date range”

Transaction date range: Click side button to select full month (1/1/2005 thru 1/31/2005)

“Schedule”

“OK”

“Close”

“OK”

Wait for the report to run - Click “Finished Reports” to view report

MONTHLY REPORTS: Electronic Database Statistics

Electronic Database statistics lets us know how often students and staff are using our electronic resources. It's best if these statistics are kept on a monthly basis.

Where can I find the statistics spreadsheet?

On the K drive under library, stats, database stats. Look for the current fiscal year.

Where can I find information about what statistics we collect, usernames, passwords, etc.?

That information can be found in the same folder. The name of the file is Database Statistics Locations.

What do we collect?

Total searches, sessions, and turnaways for each electronic database. We also collect statistics for the Proxy Server and Serial Solutions.

How do we collect it?

Some vendors will email us the statistics. Information on how to set that up is in the Database Statistics Locations. Most vendors require going to the vendor website each month.

MONTHLY REPORTS: Collection Development—Items Added

There are a couple of ways to figure out the items added. The Librarian usually does this task, but Technicians can do it too.

Run a report on Sirsi.
In the reports toolbar...
Click “Schedule New Reports”
Click the “Bibliographic” tab
Click “Count Items”
Click “Schedule”
Click the “Selection Criteria” tab

Suppose you want to know how many books were added in April 2001...

You need to use the diamond buttons to fill in the categories.
Library = GREATFALLS
Home location = FASTBACK, JUVENILE, NEWBOOKS, OFFICECOPY, OVERSIZE, REFERENCE, STACKS
Item type = BOOK
Date created – Click the diamond
 Click “Range”
 Fill in the dates as 01/01/2005 and 01/31/2005
 Click “OK”
Click “Schedule”
Click “OK”
Click “Close”
Wait for the report to run (a few minutes to an hour)
Click “Finished Reports”
Click “Count Items”
Click “View”
Click “OK”

The report will display on Word or WordPad.

You would run a separate report for videos, just make: Home location = VIDEO, NEWBOOKS
Item type = CASSETTE, CD-AUDIO, CD-ROM, DVD, KITS, SLIDE, VIDEO

MONTHLY REPORTS: Statistical Reports— Gate Count Activity

Gather the completed “Gate Count” sheets for the entire month. Extra copies of the Gate Count sheets are in the top drawer by the circulation computer.

Open the “**Library\Stats\Gate activity**” folder and the excel file for the appropriate month. To the right of the actual entries on the excel form are the programmed calculations to enter the gate counts that will calculate the actual activity for a given day. This will be the difference between the evening and morning count divided by two (this accounts for each individual entering and leaving the library).

Manually record the daily count at the bottom of the each daily column on the “Gate Count” sheet. Enter the amounts in the appropriate day-week area on the excel file. Save and close the file. Make a copy of the excel file (use the copy as the template for the next month). Move the original file to the appropriate year folder in the Library Stats. Rename the copy to the next month, using the “01-2008.xls” format (be sure to change the month names in the file also).

Manually record the difference on the last day sheet between the last monthly entry and the first monthly entry divided by two on the last “Gate Count” sheet for the given month. Enter the total into the “Total Gate Count Report by Fiscal Year.xls” spreadsheet. Add the total to the graph by adding the month and total to the bottom of the list on the right side of the sheet and extending the graph’s data range to include the new month.

Staple the gate counts and the spreadsheet with the daily averages together and file them in the appropriate folder in the bottom drawer by the circulation computer. The library stats graph and the Fiscal Year spreadsheets get placed in the Gate Count 3-ring binder.

OVERDUES: Schedule of Billing Reports (Overdues, Fines, & Lost Items)

Reports run for overdues under the template, “GF Weekly Overdue Notices” will automatically calculate amount of reports run for a given account. This effects the overdue status making it important to only run on the scheduled generation time. Any amounts accrued for overdue faculty/staff will be forgiven when the item is returned, but the faculty/staff is still responsible for all lost/damaged book costs.

1) **Weekly** (Wednesdays) - Overdue Reports - Three notices (first, second and final) will be sent to patrons.

“Templates - GF Weekly Overdue Notices”

“Schedule”

“OK”

“Close”

See results under Finished reports (notation below)

a. In addition to the notice being sent to the patron, a courtesy phone call or email is done to remind the patron of their overdue.

b. *Any lost items (30+ days overdue) or fines in excess of \$25 Letters should be sent to 1) to the patron, 2) to Business Office, 3) retained in Library records. Notation made on patron's file and also the record for the item lost.

**Interlibrary loan overdue -- make notation in patron's record. ILL privileges will be revoked until paid. There is a list of patrons that owe ILL fees in the front of the file cabinet.

2) **End of Month** - Unpaid Fine Reports (item no longer overdue, but fines unpaid)

“Templates - Monthly Bill Template”

“set date billed range using diamond button”

“Schedule”

“OK”

“Close”

See results under Finished reports (see notation below)

Save the bills under “Library\Monthly Bills” using “01-2005.doc” name format

Click “General Options”

Password document using “holdings”

Click “OK”

Save

a. If this is their first bill, we just send the notice to the patron. If this is their final bill, we treat it as an end of the semester bill, and send them to the business office. Make three copies of individual patron, send one copy to the patron, one to the business office, and one stays here. Make a notation in the patron record indicating the bill went to the business office.

3) **End of Semester** (from end of previous semester to the end of current semester)– All unpaid bills (fines) or unpaid ILL fines are sent to the Business office

“Template - Monthly Bill Template”

“set date range for the end of the previous semester to the end of the current semester”

“OK”

“Close”

See results under finished reports (see notation below)

- a. Notice sent to patron
- b. Send copy to Business Office.
- c. Copy retained in library files.
- d. Make a notation in the patron file in SIRSI.
- e. If this is their first bill, you can just send one copy to the patron and do not forward it to the business office until the final bill is being sent.

Notation:

If the report does not show in a Word file, email the report to your address. Cut and paste into Word for editing.

Delete everything that comes before the overdue notices

Select All and change the font to 9.

Adjust the letters to one per page.

Print the overdues.

*** Note for lost items or overdue fines \$25 and over – The patron privileges are revoked until fines paid.**

****ILL patrons and courtesy borrowers may lose library privileges if fines remain unpaid or a pattern of overdues/fines is established.**

*****Patrons who have not paid their fines by the end of the semester will have their library privileges suspended until the bill is paid for. They may pay either here or at the business office.**

PERIODIC REPORTS: Collection Development—Items Added

There are a couple of ways to figure out the items added. The Librarian usually does this task, but Technicians can do it too.

Run a report on Sirsi.

In the reports toolbar...

Click “Schedule New Reports”

Click the “Bibliographic” tab

Click “Count Items”

Click “Schedule”

Click the “Selection Criteria” tab

Library = GREATFALLS

Home location = FASTBACK, JUVENILE, NEWBOOKS, OFFICECOPY, OVERSIZE, REFERENCE, STACKS

Item type = BOOK

Date created – Click the diamond

Click “Range”

Select range dates desired such as 01//01/2005 and 01/31/2005

Click “OK”

Click “Schedule”

Click “OK”

Click “Close”

Wait for the report to run (a few minutes to an hour)

Click “Finished Reports”

Click “Count Items”

Click “View”

Click “OK”

The report will display on Word or WordPad.

You would run a separate report for videos, just make: Home location = VIDEO

Item type = VIDEO, DVD

MONTHLY REPORTS: Collection Development—Items Removed

This can be determined two ways: with Sirsi, or the Removed Items List in the library's common drive under "Library\Bibliographies\Removed Items list" under title format "01-2005 Removed Titles.xls". The Sirsi report can only give numbers of what has been removed. It cannot give the 'what' after the item has been removed. The Excel spreadsheets, we started keeping in July 2001, give the 'what' of what was removed.

In the SIRSI reports toolbar...

Click "Schedule New Reports"

The "Template" tab should be on top

Click "GF Transaction Statistics"

Click "Schedule"

Click the "Selection Criteria" tab

Scroll to the **Transaction Selection** section of the window

Use the diamonds

Library: GREATFALLS

Transaction date range: click the diamond to select date range for ex: 04/01/2001 thru 04/30/2001

Click "OK"

Command: Remove Item Part B

Scroll back up to the top of the window and click the 'Output Options' tab

Column: click the diamond
category: Item type
click "OK"

Row: click the diamond
category: Item home location
click "OK"

Click "Schedule"

Click "OK"

Click "Close"

Wait for the report to run

Click "Finished Reports"

Click "GF Transaction Statistics"

Click "View"

Click "OK"

The report will come up in Word or WordPad document showing how many of each item type was removed from where that month.

To know the 'what' of what was removed, check the "removed items list" in the Inventory_Insurance folder of the library common drive. The removed items list is broken down by year, then month. Open the month you are looking for to see the 'what' of what was removed. The removed item list is set up with the title, author/publisher, ISBN, and ID Number.

Reserve items are excluded in the removed items list because they don't "belong" to the library.

PERIODIC REPORTS: Collection Development— Purge “Required Field”

“Required Field” is a title that happens when an incomplete record gets added to Sirsi. Incomplete records happen when a record is started, but exited out of rather than cancelled.

Record templates in Sirsi have the phrase “Required Field” in the title box. That’s where the phrase comes from.

To delete these incomplete records:

Use the cataloging menu

In the Title dropdown

Click “Delete Title, Call Numbers, or Items”

Search for the title, “required field” in Great Falls

Check off the ones that should be removed

Click “Delete”

Click “yes” when the “This action will remove the title. Would you like to remove the tile?” dialogue box appears

Click “Close”

PERIODIC REPORTS: Patron Fine Reports--Fines

This process will list patrons who owe money, but it cannot be used to get a monthly listing of fines.

In the reports toolbar in Sirsi...

Click "Schedule New Reports"

Click the "User" tab

Click "List Users"

Click "Schedule"

Click the "Selection Criteria" tab

Scroll to the middle section of the page where it says, "User Selection"

Use the diamonds to fill in the fields

Library: GREATFALLS

Delinquency status: DELINQUENT, BLOCKED, BARRED

Scroll back up and click the "Sorting Criteria" tab

Sorted by: user name

Click the "Output Options" tab

Put a checkmark by Address in the "User Information section

In the Bill Information section of the page...

Bills: ± All ± Paid ± Unpaid

Format: ± Brief ± Full

Click "Schedule"

Click "OK"

Now wait for the report to run

Click "Finished Reports"

Click the report to highlight it

Click "View"

Click "OK"

The report will come up on Word or WordPad. If it's on WordPad, cut and paste it over to Word. If you are mailing this out, clean it up so that there is one patron record per page.

SEMESTER REPORTS: Circulation— Renewals

The librarian keeps track of how many items were renewed each month. S/he usually does it, but may ask a technician to do it.

To find the numbers, go into the reports toolbar in Sirsi...

Click “Schedule New Reports”

Click “GF Renew Statistics”

Click “Schedule”

Click the “Selection Criteria” tab

Scroll down to the “Transaction selection” part of the page

Leave all entries alone except for “Transaction date range”

Transaction date range: erase the entry that is in the box

type the month you need as 04/01/2001:04/30/2001

(there are no spaces)

Click “Schedule”

Click “OK”

Click “Close”

Wait for the report to run

Click “Finished Reports”

Click “GF Renew Statistics”

Click “View”

Click “OK”

The report appears in Word or WordPad and is 2 pages long. Using April 2001 as an example: there were 31 periodicals, 20 stacks, and 1 video renewed for a total of 52 items.

SEMESTER REPORTS: Circulation— Reserves

The Librarian keeps track of how many reserve items circulate each month. S/he usually does it, but may ask a technician to do it.

To find the numbers, go into the reports toolbar in sirsi...

Click "Schedule New Reports"

Click "GF Reserve Statistics"

Click "Schedule"

Click the "Selection Criteria" tab

Scroll down to the "Transaction selection" part of the page

Leave all entries alone except for "Transaction date range"

Transaction date range: erase the entry that is in the box

type the month you need as 04/01/2001:04/30/2001

(there are no spaces)

Click "Schedule"

Click "OK"

Click "Close"

Wait for the report to run

Click "Finished Reports"

Click "GF Reserve Statistics"

Click "View"

Click "OK"

The report appears in Word or WordPad and is 2 pages long. Using April 2001 as an example: there were 305 reserve charges in that month.

SEMESTER REPORTS: Circulation—Interlibrary Loans

For now record keeping for ILLs is done on paper, but we have numerous reports we can run on ILLiad web reports (<http://illiad.msubillings.edu/illiad/webreports/default.html>). There are three numbers to find for each month: loan requests completed, copy requests completed, and requests we filled.

I've been gathering the numbers about every three months because loans aren't usually completed in one month. ILL stats run from 7/1 → 6/30 each fiscal year. "Returnables" and "Non-returnables" are counted by the date we send the request off to be filled. Ex: we request a book on 3/15/01 and it arrives 4/2/01. It would be counted in the stats as a March transaction. "We lent" are counted by the date we receive the request. Ex: a library requests a video from us on 3/31/01 and we send it on 4/1/01. We get it back on 5/1/01. We would count this as a stat for March.

Every few months, sort through the three completed paperwork ILL folders. You can use the transaction number to look up information on the request to see what the transaction date should be. Click **Edit** and then **Edit Request**. Type in the transaction number and click search. The date under **Transaction Date** is the day and month we count for our stats.

In each, group the papers by month and clip them together. Count the ones in the packet, and in pencil, write, "Month Year Number" on the top sheet of paper. Also write it on the inside cover of the folder in pencil. Do it in pencil because the numbers may change the next time you sit down to do this ☺

Doing these stats every few months helps eliminate a lot of work at the end of the year when you create an ILL summary report. They are helpful for the Librarian too when s/he needs circulation numbers.

ANNUAL REPORTS: Circulation—ILL Summary Report

Around the end of July, get a final count of the completed ILL transactions. The fiscal year ends on 6/30, but you should wait till the end of July or early August to do this because it takes that long for the ILL paperwork to ‘finish.’

When you have a final tally of the loan requests completed, copy requests completed, and requests that we filled, transfer the numbers to the stats in the common drive.

Open “STATS”
“ILL”

There are two documents in the ILL folder. One is called, “ILL monthly numbers” and the other is called “YTD avg and total.” The “ILL...” document is where you put the numbers that are penciled in on the inside cover of each folder. Put the numbers in the appropriate column, and then add across the row for a Monthly Total. Once you have the Monthly Totals, add down that column for the FY Total.

The “YTD...” document is where you enter the Monthly Total numbers. I suggest having both documents open so you can click between them for this part (get the calculator up too).

There are three sections to the “YTD...” document: Total transactions by month and year, Y.T.D. average total transactions by month and semester, and Transactions by percent.

Transfer the Monthly Total numbers from the “ILL...” document to the appropriate spot in the “YTD...” document in the “total transactions...” section.

When the “Total transactions...” section changes, it changes the “Y.T.D. average...” section below it. Get the calculator and recompute the averages.

To update the “transactions by percent” section, you need the “ILL...” document. In the “ILL...” document, total the year’s book column, copy column, and loan column. Divide each total by the year’s FY total to get the percents. Put the percents in the appropriate spot in the “transactions by percent” section.

The graphs on the “YTD...” document are no longer current. Delete them, and create new ones based on the new data.

ANNUAL REPORTS: Inventory & Collection Valuation

Five days before the end of June (July-June Fiscal Year), quit processing additions or deletions for the Library collection. Create an inventory report of the library’s books, videos, AV items, and periodicals for the Controller in the Business Office. The inventory is an estimate of the monetary value of the collection; it isn’t precise.

Below is a sample table for the inventory report that contains blanks to complete. blanks. The template for the report is under *Library\Inventory\Collection Activity year-year template.xls*.

Total number of books in the collection: _____	
Total number of videos in the collection: _____	
Total number of AV items in the collection: _____	
Total number of items in the collection: _____	
_____ periodical subscriptions (includes _____ newspapers) with average back file of 5 years. Yearly subscription cost \$ _____	\$ _____
BOOKS, VIDEOS, AND AV ITEMS WITH PRICE	
_____ books with price. Average price \$ _____ /volume	\$ _____
_____ videos with price. Average price \$ _____ /volume	\$ _____
_____ AV items with price. Average price \$ _____ /volume	\$ _____
BOOKS, VIDEOS, AND AV ITEMS W/O PRICE	
_____ books w/o price. Average price \$ _____ /volume	\$ _____
_____ videos w/o price. Average price \$ _____ /volume	\$ _____
_____ AV items w/o price. Average price \$ _____ /volume	\$ _____
ESTIMATE OF TOTAL VALUE OF PERIODICALS, BOOKS, VIDEOS, AND AV ITEMS	\$ _____

Reports run to get inventory results include: Count Items Report and Average Price of Books Report. Each of these must be run three times, one for each item type category. Reserve items are not counted because, for the most part, they don’t ‘belong’ to the library. The three item type categories are: books, videos (VIDEO, DVD), and AV (includes CD-AUDIO, CD-ROM, SLIDES, SOUND CASSETTES).

To count the number of books, open Sirsi to the reports toolbar.

- 1) Click *Schedule New Reports*
- 2) Click the *Bibliographic* tab
- 3) Click *Count Items*
- 4) Click *Schedule*
- 5) Click the *Selection Criteria* tab -- Click on the diamond and scroll
- 6) Library: GREATFALLS
- 7) Home location: STACKS, REFERENCE, NEWBOOKS, CURRICULUM, OVERSIZE, FASTBACK, WEEDREVIEW, OFFICE COPY & ON-REVIEW (remember, **don’t** count reserve)
- 8) Item type: BOOK
- 9) Click *Schedule*

10) Click *OK*

11) Click *Close*

The report takes 30-60 minutes to run. Save as "Count_Books_05_06.doc"

To count the number of videos, follow steps 1-6 outlined above. The Home location is CURRICULUM, AV-RACK, VIDEO, NEWBOOKS, OFFICE COPY, ON-REVIEW & WEEDREVIEW. The Item type is VIDEO, DVD. Steps 9-11 are the same. Save as "Count_Video_05_06.doc"

To count the number of AV items, follow steps 1-6 outlined above. The Home location is CURRICULUM, AV-RACK, NEWBOOKS, OFFICE COPY, ON-REVIEW, VIDEO & WEEDREVIEW. The Item type is CASSETTE, CD-AUDIO, CD-ROM, and SLIDES. Steps 9-11 are the same. Save as "Count_AV_05_06.doc"

To figure the average price of books, open Sirsi to the reports toolbar.

1) Click *Schedule New Reports*

2) Click the *Bibliographic*

3) Click *Average price of books*

4) Click *Schedule*

5) Click the *Selection Criteria* tab

6) Scroll down to the Copy Selection part of the page using the diamonds

7) Library: GREATFALLS

8) Home location: FASTBACK, CURRICULUM, NEWBOOKS, OFFICE COPY, OVERSIZE, REFERENCE, STACKS, ON-REVIEW & WEEDREVIEW (do not count reserve)

9) Item type: BOOK

10) Click *Schedule*

11) Click *OK*

12) Click *Close*

The report takes 30-60 minutes to run. Save as "Ave_Price_Books_05_06.doc"

To figure the average price of videos, follow steps 1-7 outlined above. The Home location is AV-RACK, CURRICULUM, VIDEO, NEWBOOKS, ON-REVIEW, OFFICE COPY & WEEDREVIEW. The Item type is VIDEO, DVD. Steps 10-12 are the same. Save as "Ave_Price_Video_05_06.doc"

To figure the average price of AV items, follow steps 1-7 outlined above. The Home location is AV-RACK, CURRICULUM, VIDEO, NEWBOOKS, ON-REVIEW, OFFICE COPY & WEEDREVIEW. The Item type is CASSETTE, CD-AUDIO, CD-ROM, SLIDES. Steps 10-12 are the same. Save as "Ave_Price_AV_05_06.doc"

Now, for the actual inventory report...

Fill in the total number of books/videos/AV items by using the count reports that were just completed.

Obtain a total count of current serial holdings and newspapers. To find the yearly subscription cost, check the last page of the most recent EBSCO invoice, or check EBSCO on-line for the total. Keep in mind that there are separate EBSCO accounts for regular serials (dv1100004). These costs are multiplied by 5 because most subscriptions are kept for 5 years.

Fill in the BOOKS, VIDEOS, and AV ITEMS WITH PRICE sections using the information in the completed Average Price Reports. The items W/O Price can be calculated manually for the same reports (Total Items Found - Items selected with a price greater than \$0.00)

Example: The library has a total of 5554 books
 The amount of books with a price is 1301
 The average price of those is \$19.66/volume
 Subtract 1301 from 5554 to find the number of books without a
 price ($5554-1301=4253$)
 Use the same average price for the books that don't have a
 price ($\$19.66$)
 Multiply the average price with the remaining books
 ($\$19.66*4253=\$86,613.98$)

Do the same for the VIDEOS and the AV ITEMS.

When all the figures are entered, add the column and fill in "Estimate of Total Value of Periodicals, Books, Videos, and AV Items".

Complete "Library Additions and Deletions for Fiscal Year XXXX-XXXX.

Run three reports "Average Price" books, videos AV", selecting date range Created July 1, XXXX to June 30, XXXX. Save the reports as "Additions_XXXX_XXXX.doc".

Check the total items deleted for the current fiscal year under "Library\Bibliographies\Removed Items list. Fill in the total amount of items deleted and check the last years report for the "average book price". Calculate the total value of the items deleted using the prior fiscal year average. Add the columns for the "Total Discards for fiscal year XXXX-XXXX.

Follow the same procedure for Video's or AV's that have been deleted for the fiscal year. Obtain the total additional items (Books, Videos, AV) for the count reports. Use the average price for the current fiscal year for the calculations. Calculate a processing fee of \$20 for all items. Add the columns for the "Total Additions cost for the fiscal year XXXX-XXXX".

When the report is complete, create a folder with the current fiscal year date. Save the report and all supportive documents in that folder on the common drive.

Print off the completed inventory table. Put this with “supporting evidence” into the Sheila’s file cabinet in the “Inventory” folder. The packet should include: the inventory table, three item count reports, two EBSCO invoices (photocopied or what was used for supporting documentation), and three average price reports.

A copy of the completed inventory table should be turned in to the Controller in the Business Office. This should be submitted five days before the end of the fiscal year to allow time for any adjustments by the Business Department.

ANNUAL REPORTS: Statistical Reports— Year End Stats Compilation

Yearly data is gathered from the monthly reports for statistical charts and numerical count comparisons.

Where can I find the report?

On the K drive under library, stats, yearly stats. Look for the appropriate fiscal year. You may have to take last years and save it under the new fiscal year.

What do we collect?

Activity - Gate Count and Days Open

Instruction - Number of Library sessions and attendees

Circulation - number of checkouts

Catalog/Collections - number of items owned

ILL activity - what we borrowed from other libraries and what we loaned to other libraries

Electronic Access- what we own, how often it was used

Where do I find the information for each of these?

Activity - Gate count can be found in the stats folder under gate activity. Days open will appear on the same spreadsheet

Instruction - Sessions and attendees can be found in the Instruction Sessions folder in Stats

Circulation - These reports are run in Sirsi. See the Monthly reports section for circulation statistics for instructions on how to do this.

Catalog/Collections - Look in the inventory folder on the common drive. The Library Technician keeps track of this and can help you find the latest report

ILL activity - This is taken from ILLIAD. The website address is

<http://illiad.msubillings.edu/illiad/webreports/default.html>

Electronic Access - This is taken from the fiscalyear database stats located in the stats folder.

ANNUAL REPORTS: Statistical Reports— Gate Count Activity

Yearly data is gathered from the monthly reports for statistical charts and numerical count comparisons. Update the chart information and chart titles to include the new information.

Enter the appropriate weekly or monthly information into the following reports:

k:\\library\\Stats\\Gate activity\\Charts\\2000-2004 chart.xls
Library September Gate Count by Week and Day

k:\\Library\\Stats\\Gate activity\\Charts\\chart2000-2004weeks.xls
Library Gate Count Increase From 2000 to 2004

k:\\Library\\Stats\\Gate activity\\Charts\\gatepercentageincrease.xls
Percentage of Gate Increase between Sept 2002- Sept 2004

k:\\Library\\Stats\\Gate activity\\Charts\\Gate count'00-'04.xls
Comparison of library usage based on gate count - % increase from previous year

MONTHLY REPORTS: Collection Development— New Books List

Details for creating the new additions list are in section I. A. 5.
Look there for information on creating and maintaining the list.

The new additions list(s) can be used for the Library Fiscal Year Statistics report. There is a section for “Books Added” and “Videos/AV Added.” Count up the books and count up the video/AV from the list and enter those numbers into the report.

WEAVER LIBRARY PROCEDURE MANUAL

Money

Overdues and Fines Overview

Register Transactions

Fines (Paying in Workflows)

Procedures for Handling Revenue

Weekly Money Drawer Reconciliation/Deposit

Fax Procedures

MONEY: Overdues and Fines

Fines are charged on overdue library materials.

Details on fines are included in the Policies section of the Library web page (see attached policies):

- ✓ Graduate Borrower
 - ✓ Undergraduate Borrower
 - ✓ Faculty/Staff Borrower
 - ✓ Community Borrower
 - ✓ Interlibrary Loan Services
-
- Upon payment of a fine, record the amount in the fine book.
 - The money is placed in the cash drawer.
 - Offer the patron a receipt, and write one if requested. For those who have paid their account in full, please note that on the receipt.
 - The fine **MUST** then be paid on the SIRSI system.
 - Please recognize any notes in the patron's record. If the business office has been notified of the bill being paid, please follow these steps:
 - Locate and remove the patron's paperwork in the "Fines/Lost Book Notices" folder in the bottom drawer to the left of the circulation computer.
 - Clear any notes in the "Extended Info" tab on SIRSI
 - Update the "Sent to BusinessOffice" spreadsheet located on the common drive under "Monthly Bills".
 - Notify the Business Office that the patron has paid the amount in full and the hold can now be removed.
 - If there are any questions, ask a librarian or technician.

REGISTER TRANSACTIONS

All Transactions EXCEPT fines

1. Type in your assigned clerk number (black numeric keys)
2. Press CLK# key
3. Type number sold (black numeric keys)
4. Press @/FOR key
5. Choose object sold (white numeric keys)
 - a. 1 = paper
 - b. 2 = Color print
 - c. 3 = Fax
 - d. 4 = Fines
 - e. 5 = Paper Packets
 - f. 13 = Found
6. Press #/TM SBTL key
 - a. Display will show subtotal
7. Type amount of money given by patron (black numeric keys)
8. Press CA/AT/NS key
 - a. Display shows change owed and cash drawer opens
9. Give change if any and close cash drawer
10. Press CLK# key twice to log off

Fines

1. Type in your assigned clerk number (black numeric keys)
2. Press CLK# key
3. Enter fine amount (black numeric keys)
4. Press @/FOR key
5. Choose fines (#4 white numeric key)
6. Press #/TM SBTL key
 - a. Display will show subtotal
7. Type amount of money given by patron (black numeric keys)
8. If patron pays with check, press CHK key
9. If patron pays with cash, Press CA/AT/NS key
 - a. Display shows change owed and cash drawer opens
10. Give change if any and close cash drawer
11. Press CLK# key twice to log off

MONEY: Fines

Patrons could have fines for a variety of reasons. Most commonly, they are because of overdues. Some have fines because of lost or damaged items.

When you take care of patron fines, record the information in the “Library fines/charges” notebook, put the money in the till, and create a receipt for the patron. (Mark paid in full or the amount owed in the record book and on the receipt.)

Next, you clear their record in Sirsi. *A picture tutorial will show how to clear their computer record, but if you feel unsure about doing so, don’t do it. You can take care of the first step and then have a Technician or Librarian take care of the second step.*

First

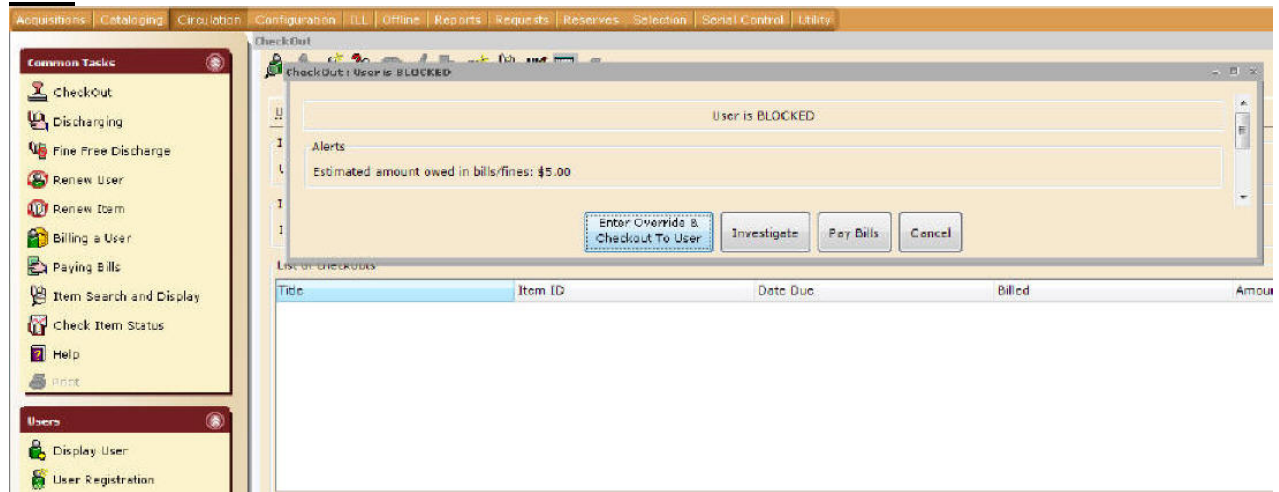

You will typically see notice fines when the person tries to check something out. A window pops up saying the person is delinquent and how much s/he owes. Click the “Investigate” button.

If a student is BLOCKED or BARRED, contact a Library Technician or the Librarian on how to proceed.

If someone comes in to pay a bill and has a question about the amount owed, ask the Library Staff.

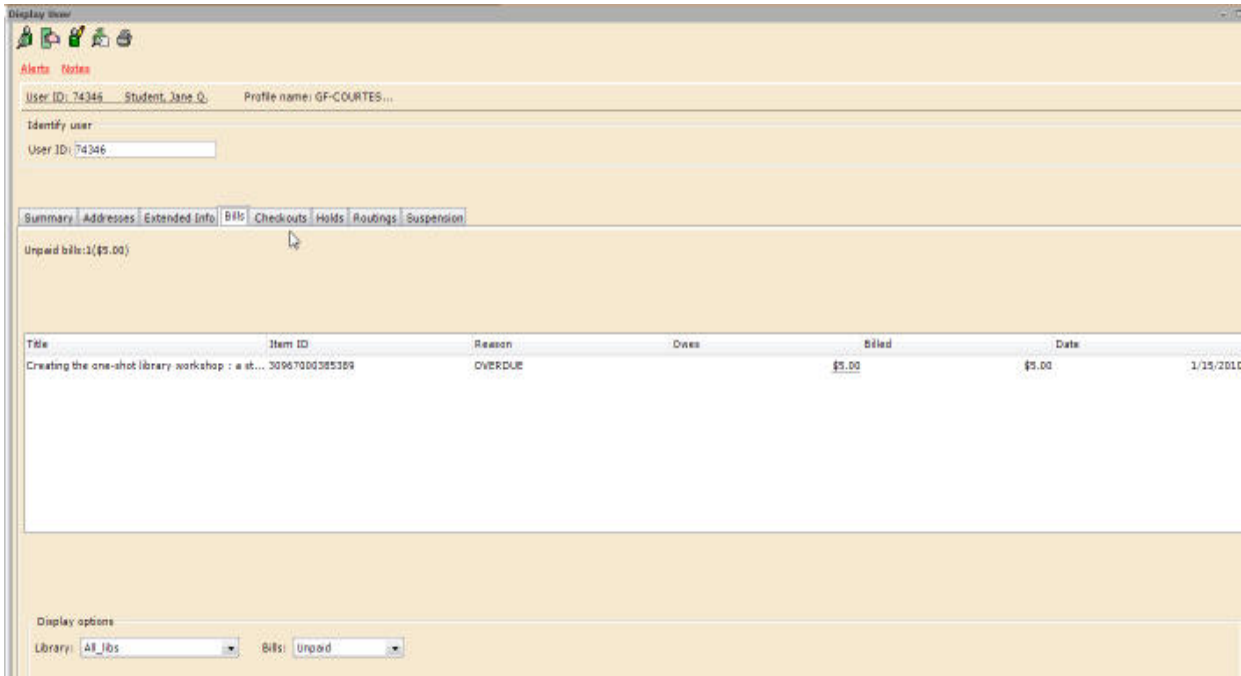

Click the “Bills” tab to see what they’re being charged for. Tell them that they have a charge, how much it is, and what it was for. Click “OK”

If their charge(s) total \$25.00 or more OR their bill has been sent to the business office already, they cannot check anything out until they have paid their entire fee.

Ask if they want to pay their fine now. If they don’t have money, they can still check things out as long as their fine is under \$25.00 and their fines have not been sent to the business office.

If they do have money and want to pay their fine, take their payment. You can also accept partial payments.

Put the money in the cash drawer. If you need to make change, there is a calculator in the coin box to help you.

The top drawer to the left of the circulation computer has the “Library fines/charges” notebook and a receipt book.

Record the payment in the “Library fines/charges” notebook. If they paid the whole thing, write, “paid in full” in the notes column. If they made a partial payment, write, “still owes \$amount” in the notes column. EX:

Date	Name (if appropriate)	Amount	For: paper, fine, other?	Notes:
3/14/02	Student, Jane Q.	\$2.50	Overdue	Paid in full
3/14/02	Student, Jane Q.	\$1.25	Overdue	Still owes \$1.25

Offer them a receipt. Library fines come under the “Other” category. Write “Library fine” on that line and the amount s/he paid. Their name goes in the “Received from” line and your name goes in the “Received by” line. Don’t worry about their SS# or program. If you aren’t comfortable with clearing the fine from the computer, click the “Checkout to user” button and continue checking things out to the student. Let a technician or librarian know that you took payment on a fine, but didn’t clear the computer.

Second

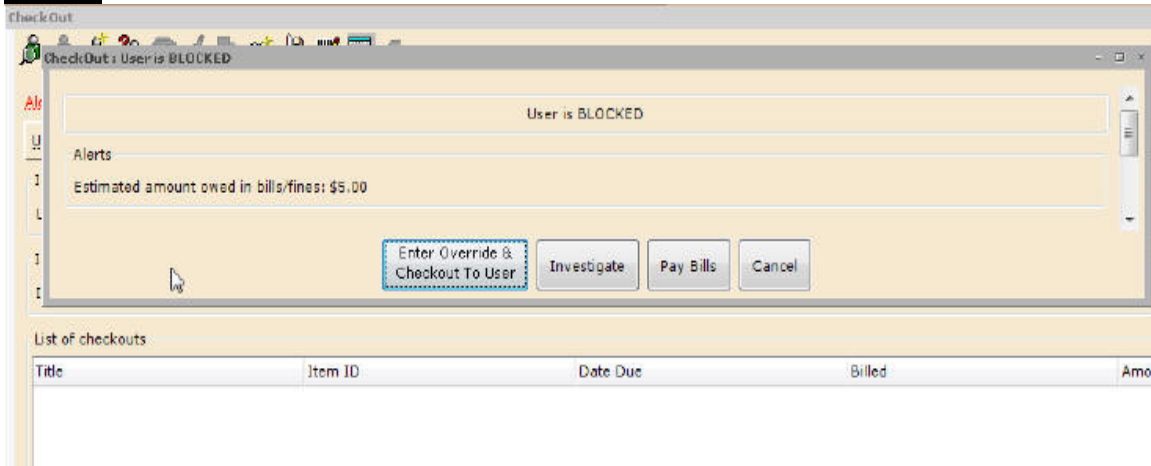

Click the “Pay bills” button

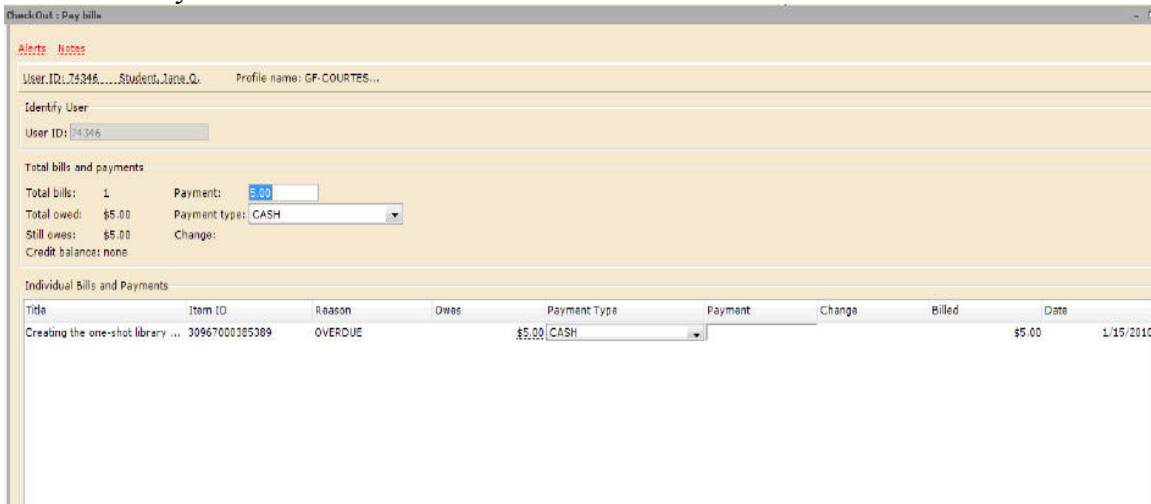

Type how much they are paying in the top payment box. If there are several items, it is best if you enter the amount paid by the items especially if it is a partial payment. Click “OK”

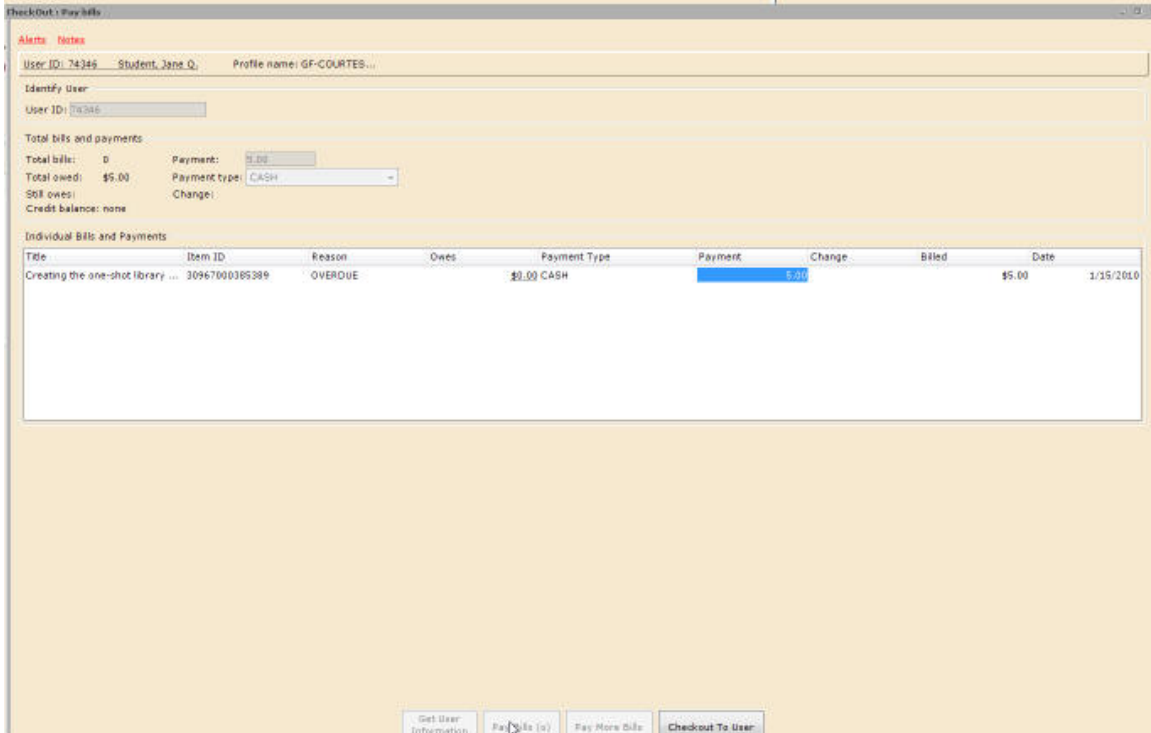

Now you can click “Checkout to user” and the regular checkout screen automatically displays.

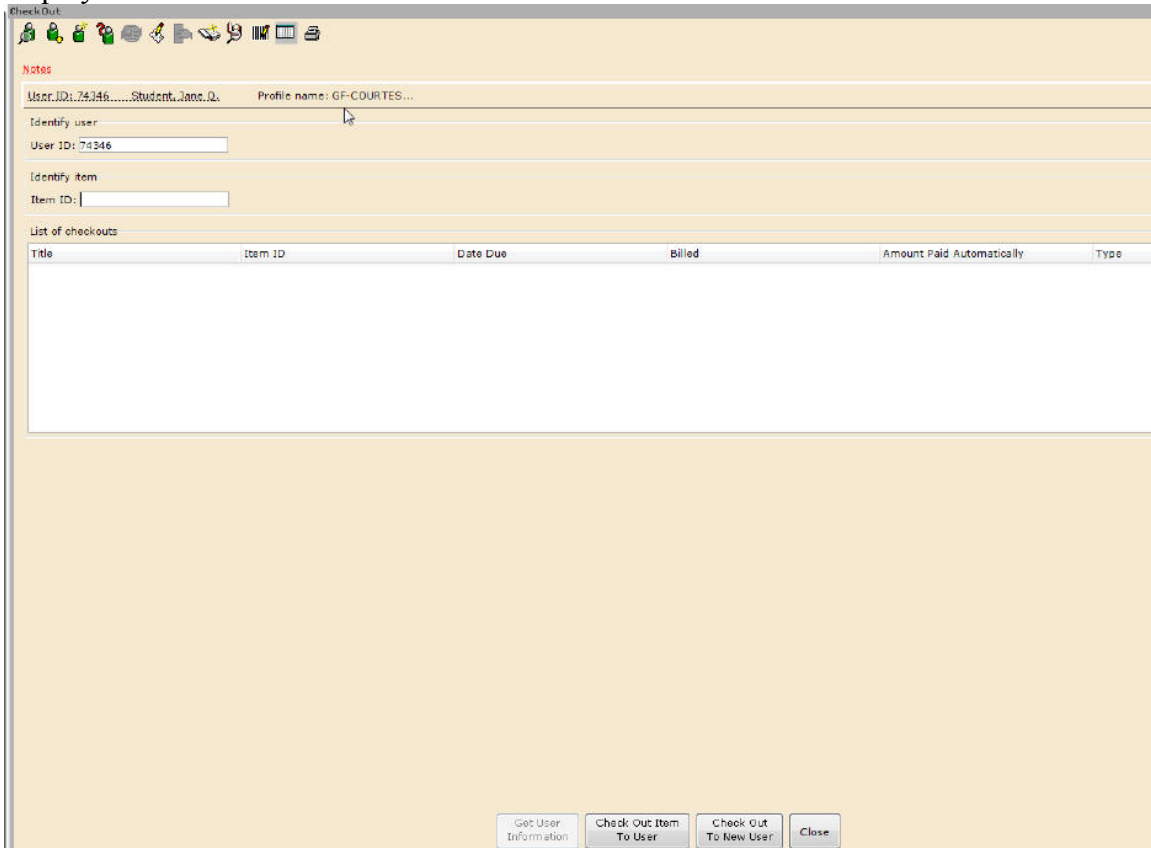

MONEY: Procedures for Handling Revenue

The Library generates revenues through paper sales, faxing, color printing, overdue fines, interlibrary loan charges, lost books charges and donations. Library policies (see collected policies) set out the charges for overdue materials, interlibrary loans, and lost books. The following are procedures the Library follows in handling those revenues:

- Maintain a minimum \$50 cash balance in the Library cash drawer at all times.
- Reconcile the cash drawer with the library charges log every Thursday.
- Deposit monies in excess \$50 with the business office every Thursday. Record the deposit amount in the money receipt book (located in the file cabinet in ILL area) and have the clerk who receives the money initial, giving them the white copy and keeping the yellow copy in the receipt book for our records. You only need to fill out one deposit slip in the receipt book.
- Obtain any change needed for the weekend hours (especially ones and quarters) at the time of deposit or on Friday afternoon.
- Report patrons with unpaid bills at the end of the semester and/or lost library items to the business office for collection.

Check cashing policy –

Checks can be used to buy paper on the weekends or to pay fines and must be written for the exact amount of purchase only. No change is given. Checks should be made out to MSU-COT.

Dishonored check policy –

A list of individuals who are barred from submitting checks is included on the “Dishonored Check Policy” which is located at the front of the “Library Fines/Charges and Student Government Charges” notebook. Updates are sent periodically from the Business Office. Do not accept any checks from these individuals on the list.

We DO NOT accept Canadian money.

MONEY: Weekly Money Drawer Reconciliation/Deposit

This task is done once a week, currently every Thursday. You need the “Library Fines/Charges and Student Government Charges” three ring binder, the “Receipts” book, a money log form (found in the Interlibrary Loan filing cabinet), a money bag, and all the cash.

The library keeps a minimum balance of \$50.00 Any excess is deposited with the business office.

Compare the receipt book with the “Library Fines...” book. Make sure all receipts written that week were entered into the “Library Fines...” book. Use the calculator on the computer if you do not have one. Add up the charges in the “Library Fines...” book. You are only adding the transactions made since the last deposit.

Most of the time, it is only library charges. Occasionally, there are Student Government (SG) charges. SG takes care of the photocopier, so photocopier related charges are deposited in the SG account.

Fill out the receipt in the receipt book, put the money in a money bag and take it to the business office for one of the accountants to count.

At the same time you make the deposit, you may want to make change. Assess the remaining \$50.00 in cash. If you have a \$10 or a \$20, it's a good idea to break it into something smaller.